



Electronic Emission Notices

Federal Communications Commission (FCC) Statement

This equipment has been tested and found to comply with the limits for a Class B digital device, pursuant to Part 15 of FCC Rules. These limits are designed to provide reasonable protection against harmful interference in a residential installation. This equipment generates, uses and can radiate radio frequency energy and, if not installed and used in accordance with instructions contained in this manual, may cause harmful interference to radio and television communications. However, there is no guarantee that interference will not occur in a particular installation.

If this equipment does cause harmful interference to radio or television reception, which can be determined by turning the equipment off and on, the user is encouraged to try to correct the interference by one or more of the following measures:

- REORIENT OR RELOCATE THE RECEIVING ANTENNA
- INCREASE THE SEPARATION BETWEEN THE EQUIPMENT AND THE RECEIVER
- CONNECT THE EQUIPMENT INTO AN OUTLET ON A CIRCUIT DIFFERENT FROM THAT OF THE RECEIVER
- CONSULT THE DEALER OR AN EXPERIENCED AUDIO/TELEVISION TECHNICIAN

NOTE: Connecting this device to peripheral devices that do not comply with Class B requirements, or using an unshielded peripheral data cable, could also result in harmful interference to radio or television reception.

The user is cautioned that any changes or modifications not expressly approved by the party responsible for compliance could void the user's authority to operate this equipment.

To ensure that the use of this product does not contribute to interference, it is necessary to use shielded I/O cables.

Copyright

This manual is copyrighted with all rights reserved. No portion of this manual may be copied or reproduced by any means.

While every precaution has been taken in the preparation of this manual, no responsibility for errors or omissions is assumed. Neither is any liability assumed for damages resulting from the use of the information contained herein.

Trademarks

All brand names, logos and registered trademarks mentioned are property of their respective owners.

Table of Contents

HARDWARE CONFIGURATION	3
Key Features	3
Motherboard Layout (Model Code No. - 35891100XX)	5
Jumper Settings	6
JP10 - CMOS Clear	6
JP41 - AMR Setting	6
Pin Assignment	7
HARDWARE SETUP	8
To Install DIMMs	8
Installing a New Processor	9
To Install a Processor to ZIF Socket	9
Connect the processor Fan Connector	9
BIOS SETUP	10
Starting Setup	10
Main Menu	11
Standard CMOS Features	12
Advanced BIOS Features	14
Advanced Chipset Features	14
Integrated Peripherals	14
Power Management Setup	14
PNP/PCI Configurations	14
Set Supervisor/User Password	14
Flash Update Procedure	16

HARDWARE CONFIGURATION

Key Features:

Chipset

- VIA® KT133 Chipset.

Processor

- Full support for AMD processors use Socket A.
- Supports bus speed of 100MHz, this includes all future processors use Socket A.

VRM 9.0 (Voltage Regulator Modules) on Board

- Flexible motherboard design with on board VRM 9.0, easy to upgrade with Future processor.

System Memory

- A total of three 168-pin DIMM sockets (3.3V Synchronous DRAM).
- Supports Synchronous DRAM at 133MHz - PC133.
- Supports Symmetrical and Asymmetrical DRAM addressing.
- Memory size up to 768M Bytes.
- Supports SDRAM and VCM SDRAM memory types.
- Supports single-density DIMMs of 1MB, 2MB, 4MB, 8MB and 16MB depth (x64).
- Supports double-density DIMMs of 2MB, 4MB, 8MB, 16MB and 32MB depth (x64).
- Supports single & double sided DIMMs.
- Banks of different DRAM types depths can be mixed.

System BIOS

- 2MB flash BIOS supporting PnP, APM, ATAPI and Windows® 95.
- Auto detects and supports LBA hard disks with capacities up to 8.4GB.
- Full support of ACPI & DMI.
- Easy to upgrade BIOS by end-user.

On-Board I/O

- On board two PCI fast IDE ports supporting up to 4 ATA, ATA2 and Ultra DMA33/66 IDE devices.
- Supports bus master IDE, PIO mode 4 (up to 16.6M bytes/sec) and Ultra DMA33/66 (up to 33/66M bytes/sec) transfer.
- One ECP/EPP parallel port .
- Two 16550-compatible UART serial ports.
- One floppy port, supports two FDDs of 360KB, 720KB, 1.2MB, 1.44MB and 2.88MB capacity.
- Four USB ports.
- PS/2 mouse port.
- Infrared (IrDA) is supported.
- One Line / Speaker out, one Mic in, one Line in and MIDI / Game port (optional).

Plug-and-Play

- Supports plug-and-play specification 1.1.
- Plug-and-play for DOS, Windows® 3.X, Windows® 95 as well as Windows® 98.
- Fully steerable PCI interrupts.

On board AC97 Sound

- Integrated AC97 controller with standard AC97 codec.
- Direct Sound and Sound Blaster compatible.
- Full-Duplex 16-bit record and playback.
- PnP and APM 1.2 support.

Power Management

- Supports SMM, APM and ACPI.
- Break switch for instant suspend/resume on system operations.
- Energy star "Green PC" compliant .
- WOL (Wake-On-Lan) Header support.
- External Modem Ring-in Wake-up support.

Expansion Slots

- 5 PCI bus master slots (Rev. 2.1 compliant).
- 1 Audio Modem Riser(AMR).
- 1 ISA slot (1 ISA slot shares with 1 PCI slot).
- 1 universal AGP slot (AGP 2.0 compliant - 4X mode support).

CAUTION

Static electricity can harm delicate components of the motherboard. To prevent damage caused by static electricity, discharge the static electricity from your body before you touch any of the computers electronic components.

Motherboard Layout (Model Code No. - 35891100XX)

The following diagrams show the relative positions of the jumpers, connectors, major components and memory banks on the motherboard.

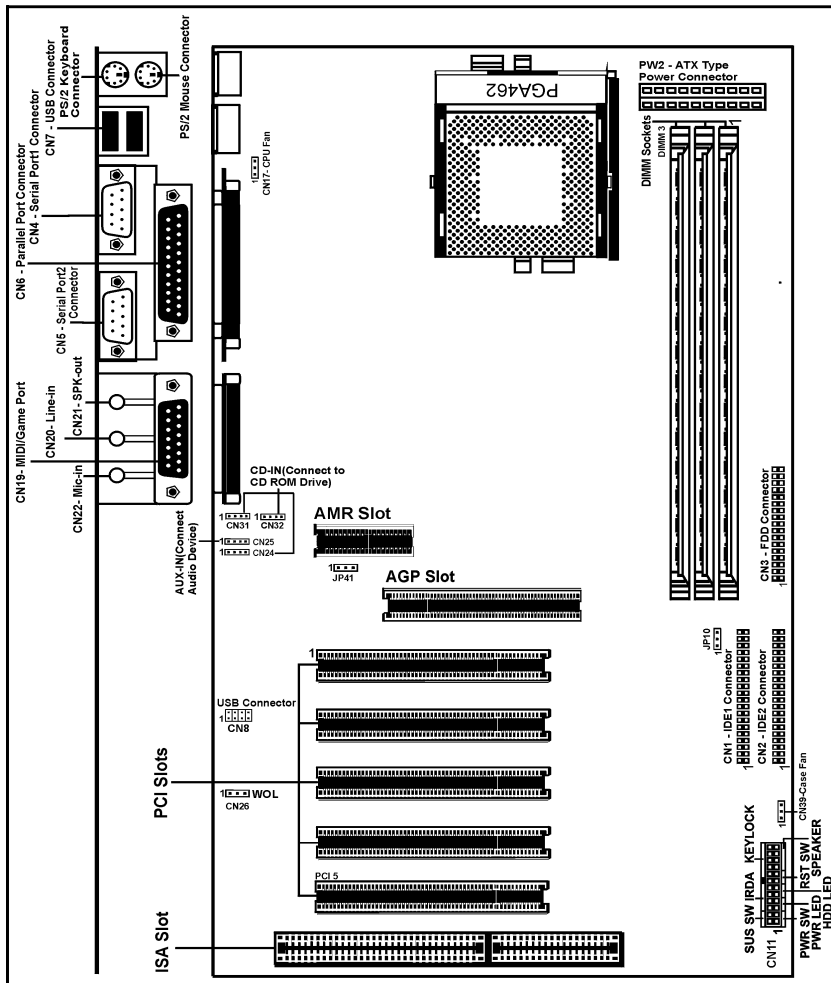

NOTE



- 1) Be sure to check the cable orientation in order to match the colored strip to the pin 1 end of the connector.
- 2) When you start up the system, please wait for 5 seconds after you power on AC.

Jumper Settings

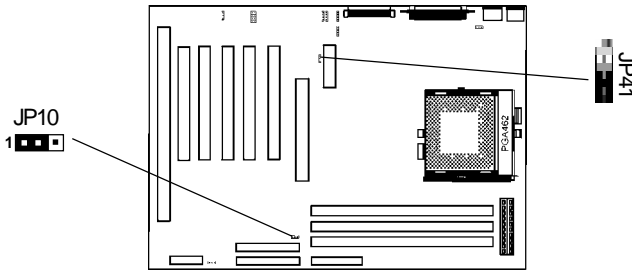

This chapter explains how to configure the motherboard's hardware. Before using your computer, make sure all jumpers and DRAM modules are set correctly. Refer to this chapter whenever in doubt.





JP10 - CMOS Clear

JP10	Selection
 1-2*	Normal*
 2-3	CMOS Clear

JP41 - AMR Setting

JP41	Selection
 1-2	Primary
 2-3*	Secondary*

 Close  Open * = Default setting

Pin Assignment

Internal Audio Connector

CN25 : AUX-IN



1

Pin	Assignment
1	AUX-L
2	GND
3	GND
4	AUX-R

CN31 : CD-IN



R G L G

Pin	Assignment
1	CD-R
2	GND
3	CD-L
4	GND

CN24 : CD-IN



1

Pin	Assignment
1	CD-L
2	GND
3	GND
4	CD-R

CN32 : CD-IN



G L G R

Pin	Assignment
1	GND
2	CD-L
3	GND
4	CD-R

CN11 FRONT PANEL HEADER HEADER 2x12

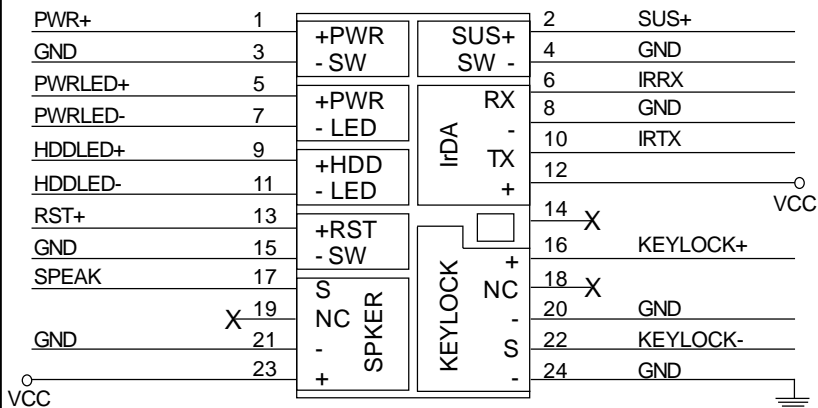

Hardware Setup

To Install DIMMs

1. Locate the DIMM sockets.
2. Holding the DIMM by the edges, remove it from its antistatic package.
3. Make sure the clips at either end of the socket are pushed away from the socket.

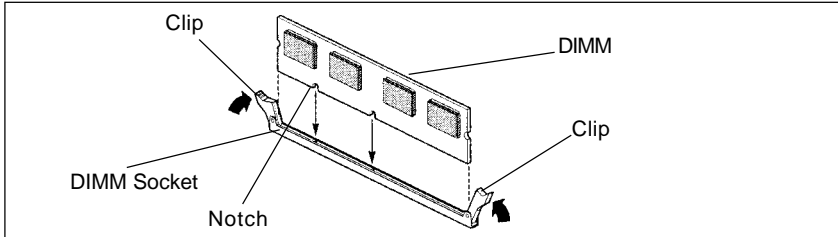

4. Position the DIMM above the socket. Align the two small notches in the bottom edge of the DIMM with the keys in the socket.
5. Insert the bottom edge of the DIMM into the socket.
6. When the DIMM is seated, push down on the top edge of the DIMM until the retaining clips at the ends of the socket snap into place. Make sure the clips are firmly in place.



Turn system power off before installing and removing any device, otherwise you'll cause the system damage.

Installing a New Processor

An upgrade processor can dramatically increase general system speed and performance.

Most microprocessor upgrade kits include the following items:

- Microprocessor chip
- Installation instructions and technical data

Your system may have these features built in, or support them as upgrades.

To Install a Processor to ZIF Socket

To install the processor, follow these steps:

1. If the system microprocessor is already on the motherboard socket, you need to remove it from the motherboard socket. The socket is a Zero Insertion Force (ZIF) socket which has a metal arm at one side. Carefully grasp this arm, move it horizontally away from the socket and lift it up. Eventually you will be able to lift the chip straight up out of the socket.

Be careful not to bend any of the pins when removing the microprocessor chip from its socket. The microprocessor chip can be permanently damaged.

2. Unpack the new microprocessor chip.
3. Carefully align the processor with the correct orientation to the socket on the motherboard.
4. Carefully insert the processor into the socket, and move the metal arm downward to replace it in its original position.

Connect the Processor Fan Connector

There is a fan attached the processor to prevent the overheating. Connect the processor fan cable to the fan connector that located on the motherboard near the processor and ensure the fan can operate. Otherwise the CPU can overheat and cause ***damage to both CPU and motherboard.***

BIOS SETUP

This chapter discusses Award's Setup Program built into the ROM BIOS. The Setup Program allows users to modify the basic system configuration. This special information is then stored in battery-backed RAM, which retains the setup information when the power is turned off.

Starting Setup

The Award BIOS is immediately activated when you turn on the computer. The BIOS reads the system information contained in the CMOS and begins the process of checking out the system and configuring it. When it finishes, the BIOS will seek an operating system on one of the disks and then launch and turn control over to the operating system.

While the BIOS is in control, the Setup Program can be activated:

1. By pressing immediately after switching the system on, or
2. By pressing the key when the following message appears briefly at the bottom of the screen during the POST (Power On Self Test)

Press DEL to enter SETUP

If the message disappears before you can respond and you still wish to enter Setup, restart the system to try again by turning it OFF then ON or pressing the "RESET" button on the system case. You may also restart by simultaneously pressing the <Ctrl>, <Alt>, and <Delete> keys. If you do not press the keys at the correct time and the system does not reset, an error message will be displayed and you will again be asked to ...

PRESS F1 TO CONTINUE, DEL TO ENTER SETUP

Getting Help

Press F1 to pop up a small help window that describes the appropriate keys to use and the possible selections for the highlighted item. To exit the Help Window press <Esc> or the F1 key again.

In Case of Problems

If, after making and saving system changes with the Setup Program, you discover that your computer does not reset, use the Award BIOS defaults to override the CMOS settings.

Main Menu

Once you enter the Award BIOS CMOS Setup Utility, the Main Menu will appear on the screen. The Main Menu allows you to select from various setup functions and two exit choices. Use the arrow keys to select among the items and press <Enter> to accept and enter the sub-menu.

CMOS Setup Utility - Copyright (C) 1984-1999 Award Software

<ul style="list-style-type: none"> ▶ Standard CMOS Features ▶ Advanced BIOS Features ▶ Advanced Chipset Features ▶ Integrated Peripherals ▶ Power Management Setup ▶ PnP/PCI Configurations ▶ PC Health Status 	<ul style="list-style-type: none"> ▶ Frequency/Voltage Control Load Fail-Safe Defaults Load Optimized Defaults Set Supervisor Password Set User Password Save & Exit Setup Exit Without Saving
Esc : Quit	↑↓→← : Select Item
F10 : Save & Exit Setup	
Time, Date, Hard Disk Type	

(Note : The figures of BIOS Setup Menu included here only show a typical case, and may not be exactly the same as the one on your unit.)

Note that a brief description of each highlighted item will appear at the bottom of the screen.

Standard CMOS Features This setup page includes all the items of Award™ special standard features.

Advanced BIOS Features This setup page includes all the items of Award™ special enhanced features.

Advanced Chipset Features This setup page includes all the items of chipset special features.

Integrated Peripherals This section page includes all the items of IDE hard drive and Programmed Input / Output features.

Power Management Setup This entry only appears if your system supports Power Management "Green PC" standards.

PNP/PCI Configurations This entry appears if your system supports PNP/PCI.

PC Health Status Display CPU/System Temperature, Fan Speed.

Frequency/Voltage Control CPU speed setting are settings of CPU speed. You should refer to your CPU marking.

Load Fail-Safe Defaults The BIOS defaults have been set by the manufacturer and represent settings which provide the minimum requirements for your system to operate.

Load Optimized Defaults The chipset defaults are settings which provide for maximum system performance. While Award has designed the custom BIOS to maximize performance, the manufacturer has the right to change these defaults to meet its needs.

Set Supervisor/ User Password Changes, sets, or disables password. It allows you to limit access to the system and the Setup Program.

Save & Exit Setup Saves value changes to CMOS and exits setup.

Exit Without Saving Abandons all CMOS value changes and exits setup.

Standard CMOS Features

The items in Standard CMOS Setup Menu are divided into 10 categories. Each category includes one or more setup items. Use the arrow keys to highlight the item and then use the <PgUp> or <PgDn> key to select the desired value in each item.

CMOS Setup Utility - Copyright (C) 1984-1999 Award Software
Standard CMOS Features

Date (mm :d :yy)	Tue, May 11 1999	Item Help
Time (h h :mm:ss)	11 : 1 : 35	
▶ IDE Primary Master	Press Enter 4303 MB	Menu Level ▶
▶ IDE Primary Slave	Press Enter None	Change the day, month, year and century
▶ IDE Secondary Master	Press Enter None	
▶ IDE Secondary Slave	Press Enter None	
Drive A	1.44M, 3.5 in.	
Drive B	None	
Video	EGA/VGA	
Halt on	All Errors	
Base Memory	640K	
Extended Memory	30720K	
Total Memory	31744K	

↑↓→←Move Enter: Select +/-/PU/PD : Value F10 : Save ESC : Exit F1 :General Help
F5 : Previous Values F6 : Fail-Safe Defaults F7 : Optimized Defaults

(Note : The figures of BIOS Setup Menu included here only show a typical case, and may not be exactly the same as the one on your unit.)

Date	The date format is <day-of-the-week>. <day> <month> <year>.														
Time	The time format is <hour> <Minute> <second> displayed in 24-hour military-time clock. For example, 1 p. m. is displayed as 13:00:00.														
Primary Master/Primary Slave/Secondary Master/Secondary Slave	<p>These categories identify the types of the two channels that have been installed in the computer.</p> <p>If you select Type "Manual", you will need to know the information listed below. Enter the information directly from the keyboard and press <Enter>. This information should be included in the documentation from your hard disk vendor or the system manufacturer.</p> <p>If the controller of the HDD interface is SCSI, the selection shall be "None".</p> <p>If you select Type "Auto", the BIOS will auto-detect the HDD and CD-ROM drive at the POST stage and show the IDE for the HDD and CD-ROM drive.</p> <table> <tr> <td>TYPE</td> <td>-Drive type</td> </tr> <tr> <td>CYLS</td> <td>-Number of cylinders</td> </tr> <tr> <td>HEADS</td> <td>-Number of heads</td> </tr> <tr> <td>PRECOMP</td> <td>-Write precom</td> </tr> <tr> <td>LANDZONE</td> <td>-Landing zone</td> </tr> <tr> <td>SECTORS</td> <td>-Number of sectors</td> </tr> <tr> <td>MODE</td> <td>-Mode type</td> </tr> </table> <p>If a hard disk has not been installed, select NONE and press <Enter>.</p>	TYPE	-Drive type	CYLS	-Number of cylinders	HEADS	-Number of heads	PRECOMP	-Write precom	LANDZONE	-Landing zone	SECTORS	-Number of sectors	MODE	-Mode type
TYPE	-Drive type														
CYLS	-Number of cylinders														
HEADS	-Number of heads														
PRECOMP	-Write precom														
LANDZONE	-Landing zone														
SECTORS	-Number of sectors														
MODE	-Mode type														
Drive A Type / Drive B Type	This category identifies the types of floppy disk drive A or drive B that has been installed in the computer.														
Video	The default setting is EGA/VGA.														

Advanced BIOS Features

This section allows you to configure your system for basic operation. You have the opportunity to select the system's default speed, boot-up sequence, keyboard operation, shadowing and security.

Advanced Chipset Features

The Chipset Features Setup option is used to change the values of the chipset registers. These registers control most of the system options in the computer.

This section allows you to configure the system based on the specific features of the installed chipset. This chipset manages bus speeds and access to system memory resources, such as DRAM and the external cache. It must be stated that these items should not be altered. The default settings have been chosen because they provide the best operating conditions for your system.

Integrated Peripherals

The Integrated Peripherals Setup allows the user to configure the onboard IDE controller, floppy disk controller, the printer port and the serial ports.

Power Management Setup

The Power Management Setup Menu allows you to configure your system to most save energy while operating in a manner consistent with your own style of computer use.

PNP/PCI Configurations

This section describes how to configure the PCI bus system. This section covers some very technical items and it is recommended that only experienced users should make any changes to the default settings.

Set Supervisor/User Password

You can set either supervisor or user password, or both of them. The difference between them are:

Supervisor Password : You can enter the Setup Program and change the options of the setup menus.

User Password : You can enter the Setup Program but cannot change the options of the setup menus.

When you select this function, the following message will appear at the center of the screen to assist you in creating a password.

ENTER PASSWORD:

Type the password, up to eight characters in length, and press <Enter>. The new password will clear the previously entered password from the CMOS memory. You will be asked to confirm the password. Type the password again and press <Enter>. You may also press <Esc> to abort the selection and operate without a password.

To disable a password, just press <Enter> when you are prompted to enter the password. A message will be displayed to confirm that the password is disabled.

PASSWORD DISABLED.

Once the password is disabled, the system will reset and you can enter the Setup Program freely.

When a password is enabled, you will be prompted to enter it every time you try to enter setup. This prevents an unauthorized person from changing any setting of your system configuration.

In addition, when a password is enabled, you can require the BIOS to request a password every time your system is rebooted. This would further prevent unauthorized use of your computer.

The password requirement is defined by the Security Option of the BIOS Features Setup Menu. If the Security Option is set to "System", the password will be required both at resetting and at entering setup. If the option is set to "Setup", the prompt only appears when you try to enter setup.

Flash Update Procedure

A program AWDFLASH.EXE is included in the utility diskette or CD. The user is recommended to follow the procedure below to update the flash BIOS.

1. Create a DOS-bootable floppy diskette. Copy the new BIOS file (just obtained or downloaded) and the utility program AWDFLASH.EXE to the diskette.
2. Allow the PC system to boot from the DOS diskette.
3. At the DOS prompt, key in

AWDFLASH
and hit <ENTER>

4. Enter the file name of the new BIOS.
5. The question: "Do you want to save file?" is displayed.

Key in "N" if there is no need to save the existing BIOS content..
Key in "Y" if a backup copy of the existing BIOS is needed.
(A file name has to be assigned to the existing BIOS binary file.)

6. The question : "Are you sure to program?" is displayed.

Key in "Y"

7. Wait until the flash-update is completed.
8. Power down the PC system.
9. Restart the PC.

Warning:

DO not turn off or RESET the computer during the flash process.

If you are unsure how to upgrade the BIOS, it is best to take your computer to an Authorized Service Center and have a trained technician do the work for you.