



Electronic Emission Notices

Federal Communications Commission (FCC) Statement

This equipment has been tested and found to comply with the limits for a Class B digital device, pursuant to Part 15 of FCC Rules. These limits are designed to provide reasonable protection against harmful interference in a residential installation. This equipment generates, uses and can radiate radio frequency energy and, if not installed and used in accordance with instructions contained in this manual, may cause harmful interference to radio and television communications. However, there is no guarantee that interference will not occur in a particular installation.

If this equipment does cause harmful interference to radio or television reception, which can be determined by turning the equipment off and on, the user is encouraged to try to correct the interference by one or more of the following measures:

- REORIENT OR RELOCATE THE RECEIVING ANTENNA
- INCREASE THE SEPARATION BETWEEN THE EQUIPMENT AND THE RECEIVER
- CONNECT THE EQUIPMENT INTO AN OUTLET ON A CIRCUIT DIFFERENT FROM THAT OF THE RECEIVER
- CONSULT THE DEALER OR AN EXPERIENCED AUDIO/TELEVISION TECHNICIAN

NOTE: Connecting this device to peripheral devices that do not comply with Class B requirements, or using an unshielded peripheral data cable, could also result in harmful interference to radio or television reception.

The user is cautioned that any changes or modifications not expressly approved by the party responsible for compliance could void the user's authority to operate this equipment.

To ensure that the use of this product does not contribute to interference, it is necessary to use shielded I/O cables.

Copyright

This manual is copyrighted with all rights reserved. No portion of this manual may be copied or reproduced by any means.

While every precaution has been taken in the preparation of this manual, no responsibility for errors or omissions is assumed. Neither is any liability assumed for damages resulting from the use of the information contained herein.

Trademarks

All brand names, logos and registered trademarks mentioned are property of their respective owners.

Table of Contents

| | |
|---|-----------|
| HARDWARE CONFIGURATION | 4 |
| Key Features | 4 |
| MOTHERBOARD LAYOUT | 7 |
| REAR PANEL | 8 |
| AUDIO CONFIGURATION | 10 |
| SPEAKER CONFIGURATION | 10 |
| Method 1: 4/6 Surround audio output of back panel only | 10 |
| Method 2: Using S-Bracket connectors | 12 |
| JACK-SENSING INSTRUCTION | 15 |
| CONNECTORS | 18 |
| Floppy Disk Drive Connector:CN3 | 18 |
| Hard Disk Connectors:CN1 | 18 |
| Back Panel Bracket-Six Channel Audio Output Connector:CN7 | 19 |
| Fan Power Connectors: CPUFAN/SYSFAN | 21 |
| AUX-IN Connector:AUX1 | 22 |
| CD-IN Connector:CDS1 | 22 |
| Serial ATA Hard Disk Connectors:SATA1/SATA2/SATA3/SATA4 | 23 |
| Front Panel Audio Header:FP-S1 | 25 |
| IEEE 1394 Connector:CN9 | 26 |
| USB Connectors:FP-U1/FP-U2 | 28 |
| Front Panel Header:FP1 | 29 |
| JUMPER SETTING | 30 |
| JP1 - CMOS Clear | 30 |
| Keyboard Power Select Jumper: JP5 | 30 |
| CPU Frequency Jumper: JP2/JP21 | 30 |

| | |
|------------------------------------|-----------|
| SLOTS | 31 |
| CPU INSTALLATION | 32 |
| INSTALL DDR DIMMs | 35 |
| MEMORY CONFIGURATIONS | 36 |
| Single Channel Mode | 36 |
| Dual Channel Mode | 37 |
| BIOS SETUP | 38 |
| Starting Setup | 38 |
| Main Menu | 39 |
| Standard CMOS Features | 40 |
| Advanced BIOS Features | 41 |
| Advanced Chipset Features | 41 |
| Integrated Peripherals | 41 |
| Power Management Setup | 41 |
| PNP/PCI Configurations | 41 |
| PC Health Status | 41 |
| Frequency/Voltage Control | 41 |
| Set Supervisor/User Password | 42 |
| Flash Update Procedure | 43 |
| APPENDIX | 44 |

HARDWARE CONFIGURATION

Key Features :

Chipset

- Intel® 915G/915P/915GV/910GL Chipset.

Processor

- Supports Intel® Pentium® 4, Northwood and Prescott processors in the 478-pin package (**with 0.8V~1.6V voltage**)
- Supports 64-bit PSB (Processor System Bus) frequency of 533MHz (133MHz bus clock)
- Supports 64-bit PSB (Processor System Bus) frequency of 800MHz (200MHz bus clock) (only for 915G/GV/P)
- Supports Hyper-Threading Technology.

VRM 10.1 (Voltage Regulator Modules) on Board

- Flexible motherboard design with on board VRD 10.1, easy to upgrade with future Intel® Pentium® 4 processors.
- The Intel Pentium® 4 Processors built-in L2 Cache.

System Memory

- A total of two 184pin DDR SDRAM sockets.
- DIMM size from 64 Mbytes to 2Gbyte.
- Support Dual Channel 128-bit Wide Memory Interface
- Support DDR 333/400 DDR SDRAM memory type.
- 2.5V DRAM interface for DDR SDRAM.

System BIOS

- PnP, APM, ATAPI for Windows®2000/XP.
- Full support of ACPI & DMI.
- Auto detects and supports LBA harddisks with capacities over 160GB.
- Easy to upgrade BIOS by end-user.

On-board AC97 Sound (optional)

- Integrated AC97 controller with standard AC97 Codec.
- Direct Sound and Sound Blaster compatible.
- Full-Duplex 16-bit record and play back.
- PnP and APM 1.2 support.
- Windows®2000/XP drivers ready.
- Line-in, Line-out, Mic-in .
- Supports ALC650/655 AC97 Code for six sound channel output (optional).
- ALC655 supports SPK-out, MIC-in, LINE-in, jack sensing.

Plug-and-Play

- Supports Plug and Play specification 1.1.
- Plug and Play for Windows®2000 as well as Windows®XP.
- Fully steerable PCI interrupts.

On-board I/O

- On board one PCI fast IDE ports supporting up to 2 ATA, ATA2 , Ultra ATA33/66/100 IDE HDDs, CD-ROMs, ZIP drives and LS-120 drives as boot drive.
- Support Bus Master IDE, Read transfers up to 100MB/s, Writes to 89MB/s.
- One ECP/EPP parallel port.
- One 16550 Compatible UART serial port (Two serial ports for 915P).
- One floppy port supports two FDD of 360KB, 720KB, 1.2MB , 1.44MB and 2.88MB capacity.
- Eight USB ports.
- PS/2 keyboard connector.
- PS/2 mouse is supported.
- One Front Panel Sound Connector.
- Infrared (IrDA) is supported via a header.

On-board Realtek RT8100C LAN (optional)

- Integrated 10/100 transceiver.
- Supports Full Duplex flow control(IEEE802.3x)
- Fully compliant with IEEE802.3, IEEE802.3u, IEEE802.3ab.
- Supports Wake-On-LAN function and remote wake-up.
- Transmit/Receive FIFO (8K/64K) support.

On-board VGA (only for 915G/GV/910GL)

- Core Frequency of 333MHz.
- 3D Setup Render Engine.
- High Quality Texture Engine.
- 3D Graphics Rasterization Enhancements.
- Full 2D H/W Acceleration.
- Motion Video Acceleration.
- Up to 2048x1536 in 8 bit Color at 85Hz Refresh.
- H/W Motion Compensation Assistance for S/W MPEG2 Decode.
- Software DVD at 30fps.
- Integrated 24-bit 350MHz RAMDAC.

PCI Express Graphics interface

- One 16-lane(X16 port) PCI Express port intended for Graphics Attach, Fully compliant to the PCI Express Base Specification revision 1.0a.
- A base PCI Express frequency of 2.5GB/s only.
- PCI Express supports and Enhanced Addressing Mechanism.
- ADD2 card utilizes PCI Express Graphics x16 connector.

PCI ExpressX1 Ports

- Full PCI Express 1.0a compliant.
- Two virtual channel support for full isochronous data transfers.
- Supports for full 2.5GB/s bandwidth in each direction per X1 lane.

Expanded USB Support

- Includes 4 UHCI host controllers,increasing the number of external ports to eight.
- Includes 1 EHCI USB2.0 Host Controller that supports all eight ports (Bandwidth shared between eight ports).

Power Management

- Supports SMM, APM and ACPI.
- Break switch for instant suspend/resume on system operations.
- Energy star “Green PC” compliant.
- Hardware monitoring circuit is supported, provide voltage, temperature, fan speed, etc. monitoring (optional).
- Supports suspend-to-RAM(STR) (optional).
- External Modem Ring-in Wake-up support.

On board IEEE1394 OHCI Link Controller(optional)

- Compliant with 1394 open HCI specifications v1.0 and v1.1.
- Integrated 400Mbit 2 ports PHY.

Integrated Serial ATA host Controller

- Independent DMA operation on four ports.
- Data transfer rates of 150Mb/s.
- RAID feature support (optional).

Expansion Slots

- 1 PCI Express X16 slot.
- 1 PCI Express X1 slots.
- 2 PCI bus master slots - ver. 2.1 compliant.



Static electricity can harm delicate components of the motherboard. To prevent damage caused by static electricity, discharge the static electricity from your body before you touch any of the computers electronic components.

Motherboard Layout

The following diagrams show the relative positions of the jumpers, connectors, major components and memory banks on the motherboard.

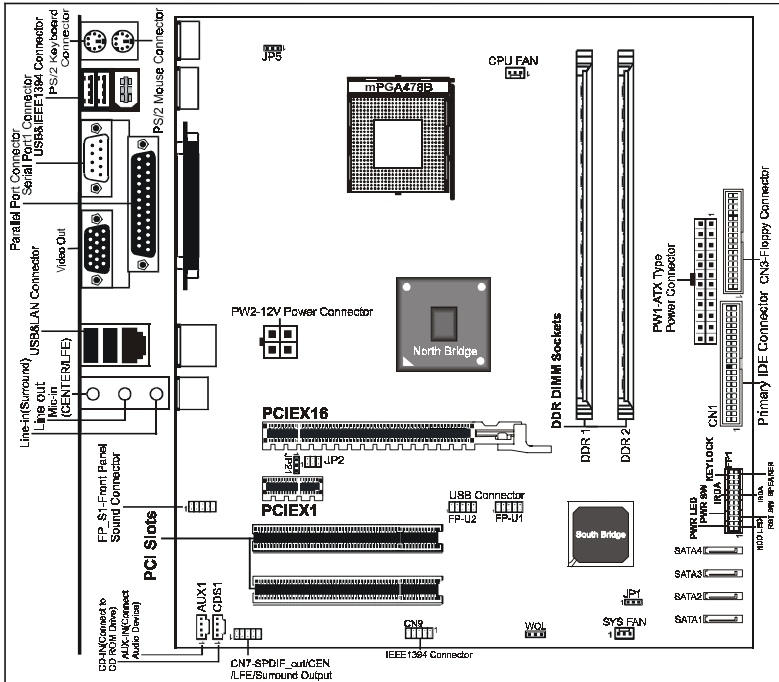

The LAN, CN7&Video out connectors are optional.

The ALC650/655 embeds an internal analog switch (by driver software) to share LINE input with Surround output, and share MIC input with CENTER/LFE output.

NOTE

- 1) Be sure to check the cable orientation in order to match the colored strip to the pin1 end of the connector.
- 2) When you start up the system, please wait for 5 seconds after you power on AC.
- 3) It is not recommended to add a metal spacer plate on the back of the Socket478. Otherwise, some components will be short and damaged.

Rear Panel

The back panel provides the following connectors:

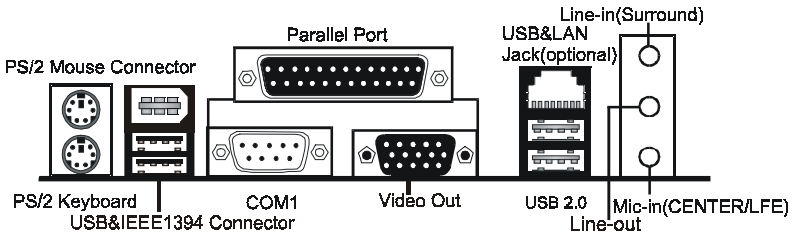

Mouse Connector

The mainboard provides a standard PS/2[®] mouse mini DIN connector for attaching a PS/2[®] mouse. You can plug a PS/2[®] mouse directly into this connector.

Keyboard Connector

The mainboard provides a standard PS/2[®] keyboard mini DIN connector for attaching a PS/2[®] keyboard. You can plug a PS/2[®] keyboard directly into this connector.

USB 2.0 Connector

The mainboard provides a UHCI (Universal Host Controller Interface) Universal Serial Bus root for attaching USB devices such as keyboard, mouse or other USB-compatible devices. You can plug the USB device directly into the connector.

USB 2.0 Connector

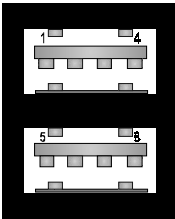

USB 2.0 Connector Description

| PIN | SIGNAL | DESCRIPTION |
|-----|---------|-------------------------|
| 1 | VCC | +5V/5VSB (optional) |
| 2 | -Data 0 | Negative Data Channel 0 |
| 3 | +Data0 | Positive Data Channel 0 |
| 4 | GND | Ground |
| 5 | VCC | +5V/5VSB (optional) |
| 6 | -Data 1 | Negative Data Channel 1 |
| 7 | +Data 1 | Positive Data Channel 1 |
| 8 | GND | Ground |

VIA VT6307 IEEE 1394 Connector (Optional)

The mainboard provides a IEEE 1394 Connector and allows you to connect a IEEE 1394 device directly to the connector.

Serial Port Connector: COM1

The Port is 16550A high speed communication ports that send/receive 16bytes FIFOs. You can attach a serial mouse or other serial devices directly to the connectors.

Video Out Connector (Optional)

The mainboard provides a Video out port to connect a 15-pin analog video monitor.

LAN Jack (Optional)

The mainboard provides one standard RJ-45 jack for connection to Local Area Network(LAN).You can connect a network cable to the LAN jack.

Parallel Port Connector:LPT

The mainboard provides a 25-pin female centronic connector as LPT. A parallel port is a standard printer port that supports Enhanced Parallel Port (EPP) and Extended Capabilities Parallel Port (ECP) mode.

Audio Port Connector

Line-out is a connector for Speakers or Headphones. **Line In** is used for external CD player, Tape player, or other audio devices. **Mic In** is a connector for microphones. The ALC650/655 embeds an internal analog switch (by driver software) to share LINE input with Surround output, and share MIC input with CENTER/LFE output.

The ALC655 embeds the jack sensing function.When you plug an audio device into the corresponding connector, the system will show you what you plugged into the motherboard.

Audio Configuration

After installing the audio driver, you can select 4/6 channel surround audio output in software utility and then connect surround speakers to appropriate audio ports.

There are two ways to obtain 4/6 channel surround audio output:

1. 4/6 surround audio output of back panel only. All surround speaker connect to audio connector.
2. S-Bracket (optional cable). You have installed S-Bracket into the computer, and then connect two front speakers to back panel's "Line-out" port, and the rest of speakers to S-Bracket. Detail connection is refer to Page 20.

Speaker Configuration

Method 1: 4/6 Surround audio output of back panel only.

After installing the audio drivers, you can attach the speakers for 2-/4-/6-channel audio output. Always connect the speakers to the LINE OUT connectors. Different connector configurations for 2-/4-/6-channel operations are listed below:

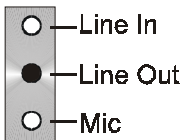

2-Channel

In 2-channel configuration, Line Out, Line In and MIC functions all exist.

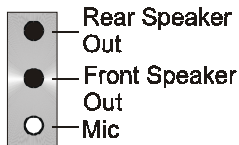

4-Channel

When set to 4-channel configuration, Line In is replaced by Rear Speaker Out. Line in function does not exist.

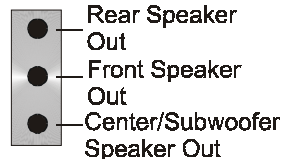

6-Channel

When set to 6-channel configuration, Line In is replaced by Rear Speaker Out. Mic is replaced by Center/Subwoofer Speaker Out. Line in and Mic do not exist function.

In utility, double click “AC97 Audio configuration” icon  from the window tray on the right bottom.

Then the “AC97 Audio Configuration” will appear. Click on the **Speaker Configuration** tab to select the audio mode.

A. When you choose 4-channel mode for 4 speaker output, the selected item is showed as below (Figure1)

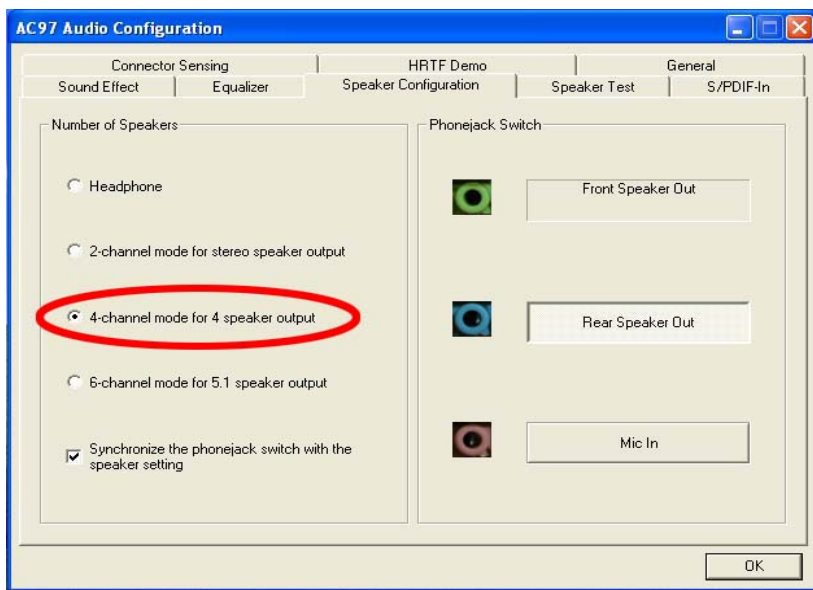

(Figure1)

B. When you choose 6-channel mode for 5.1 speaker output, the selected item is showed as below (Figure2)

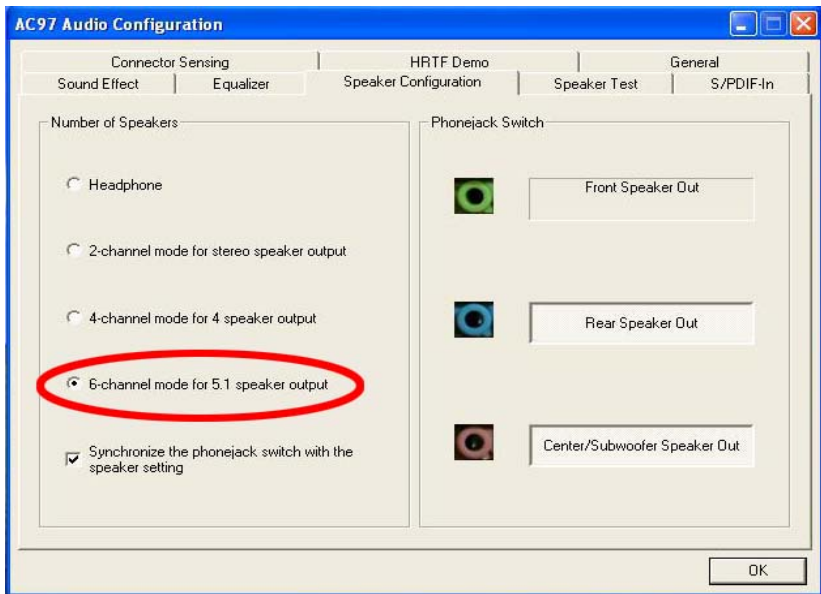

(Figure2)

Method 2: Using S-BRACKET connectors:

S-Bracket (The S-Bracket is showed in page 20) is an optional accessory. It gives access to analog and digital audio output by integrating both SPDIF and analog LINE OUT connectors. To use the S-Bracket, you should select correct setting in the software utility. For information about the setting, refer to selecting 4- or 6- Channel Setting later in the section.

Connector configurations for 4- and 6- channel using S-Bracket are described below:

4-Channel Analog Audio Output

Back Panel

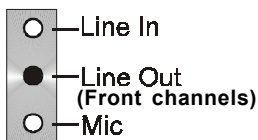

+

S-Bracket

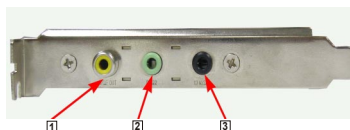

- 1 SPDIF jack (coaxial)
- 2 Rear Speaker Out
- 3 No function

Description:

Connect two speakers to back panel's **Line Out** connector and two speakers to one **Line Out** connector of S-Bracket, or four speaker to connector of S-Bracket. If you want to use **Line In** function, please click the **Rear Speaker Out** button (shown as below)

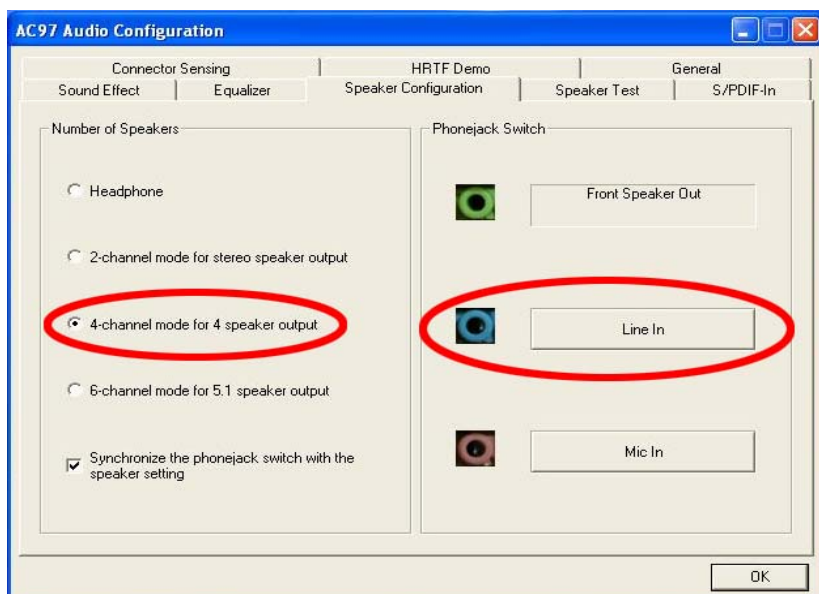

6-Channel Analog Audio Output

Back Panel

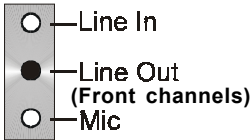

S-Bracket

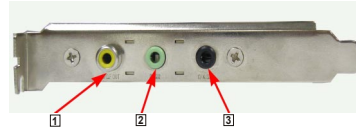

- 1 SPDIF jack (coaxial)
- 2 Rear Speaker Out
- 3 Center and Subwoofer Out

Description:

Connect two speakers to back panel's Line Out connector and four speakers to both Line Out connectors of S-Bracket. If you want to use **Line In** and **MIC** function at the same time, please click the **Rear Speaker Out** and **Center/Subwoofer Speaker Out** buttons. (shown as below)

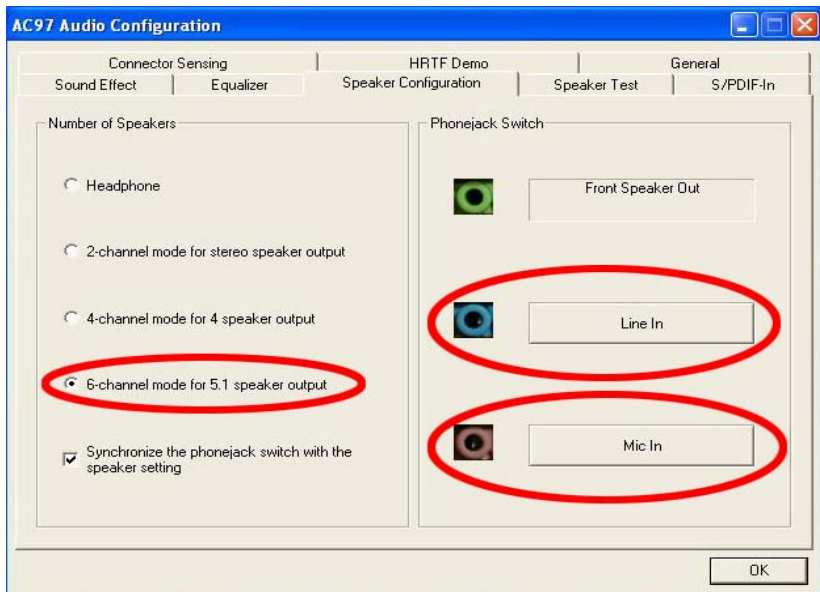

Jack-Sensing Instruction

Jack-Sensing provides audio connectors error-detection function.



Install Microsoft DirectX8.1 before to enable Jack-Sensing support for Windows 2000/XP.

Jack-Sensing includes 2 parts: AUTO and MANUAL. Following is an example for 2 channels (Windows XP):

Introduction of audio connectors

You may connect CDROM, Walkman or others audio input devices to Line In jack. speakers, earphone or others output devices to Line Out jack. and microphone to MIC In jack.

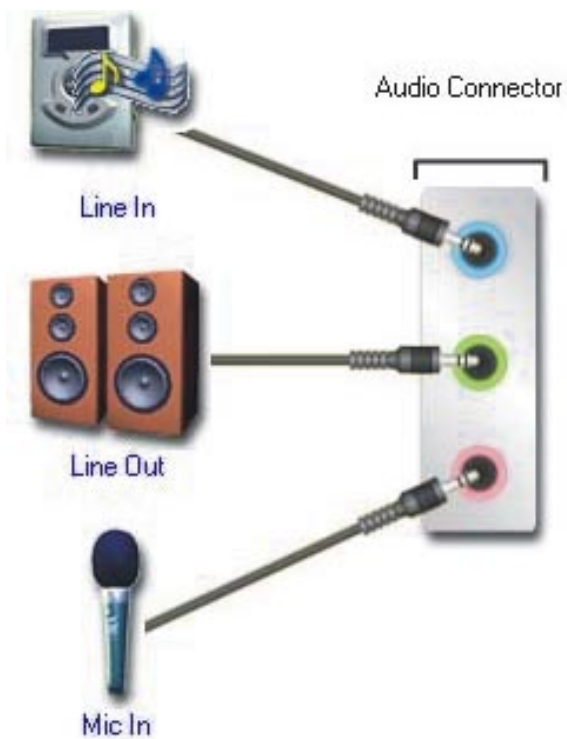

Auto-detecting:

Please connect the devices to the right jacks as above. A window will appear as below picture if you setup the devices properly.

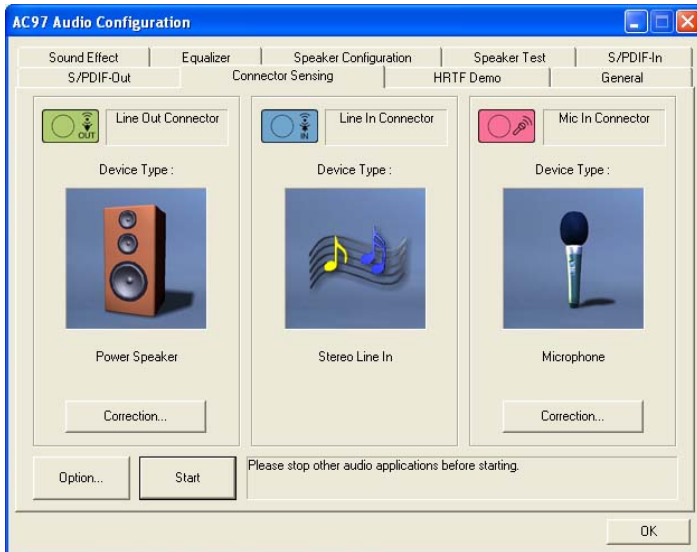

If you set wrong with the connectors, the warning message will come out as following picture.

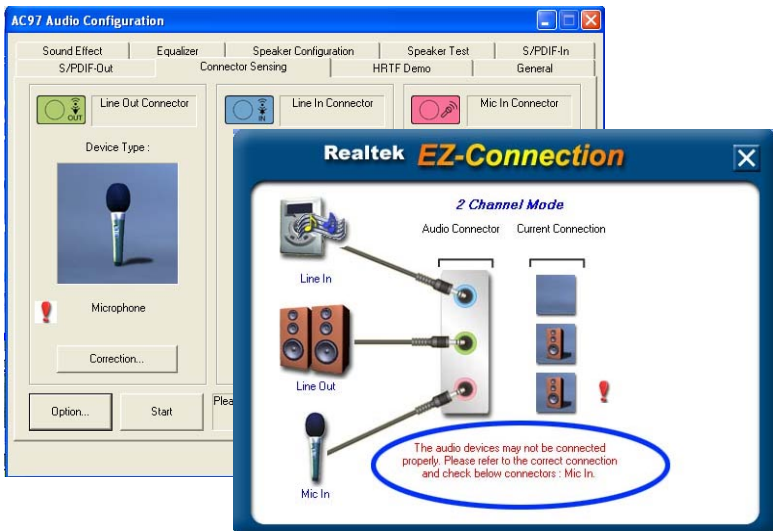

Manual setting:

If the device picture shows different from what you set, please press “Correction...” to set.

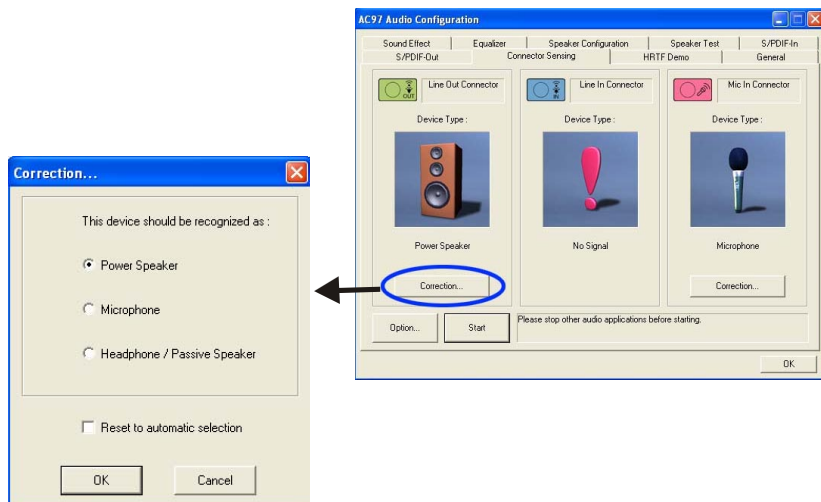

Connectors

The mainboard provides connectors to connect to FDD, IDE HDD, USB Ports ,IEEE1394, SPDIFand CPU/System FAN etc.

Floppy Disk Drive Connector:CN3

The mainboard provides a standard floppy disk drive connector that supports 360K, 720K, 1.2M, 1.44M and 2.88M floppy disk types.

Hard Disk Connectors:CN1

The mainboard has a 32-bit Enhanced PCI IDE and Ultra DMA 33/66/100 controller that provides PIO mode 0~4, Bus Master, and Ultra DMA 33/66/100 function. You can connect up to four hard disk drives, CD-ROM, 120MB Floppy (reserved for future BIOS) and other devices.

CN1 (Primary IDE Connector)

The first hard drive should always be connected to CN1.CN1 can connect a Master and a Slave drive.You must configure second hard drive to Slave mode by setting the jumper accordingly.

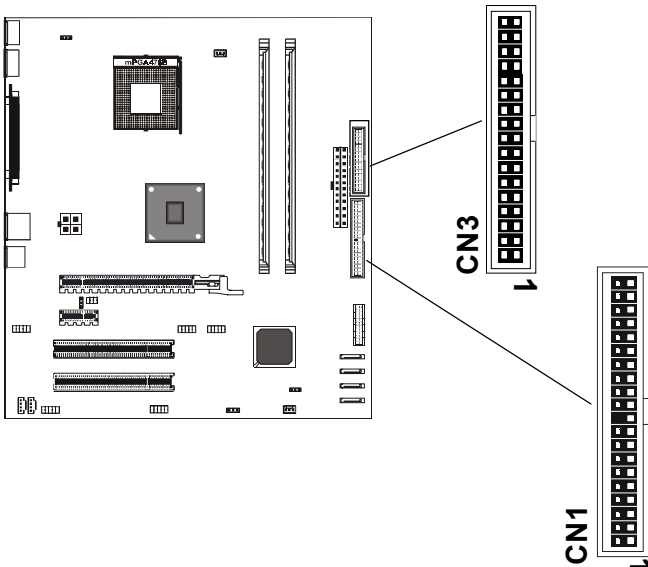

S-Bracket(SPDIF)/CEN/LFE/Surround Output Connector: CN7 (optional)

The connector allows you to connect a S-Bracket for a Digital Interface (SPDIF). The S-Bracket offers 1 SPDIF jacks for digital audio transmission and 2 analog Line-Out jacks for other 4-channel audio output. So you can use Line in, Mic in and 6 channel audio output features at the same time.

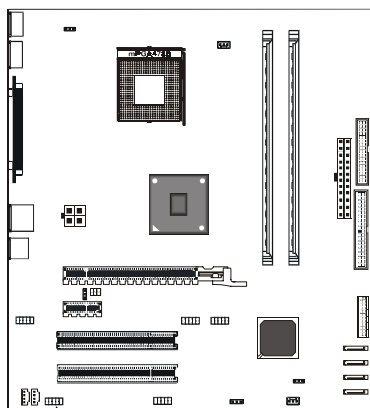

CN7-S-Bracket

| PIN | SIGNAL | DESCRIPTION |
|-----|---------|--------------------------------|
| 1 | SOUT-L | Audio left surrounding output |
| 2 | SOUT-R | Audio right surrounding output |
| 3 | GND | Ground |
| 4 | GND | Ground |
| 5 | CET-OUT | Audio center output |
| 6 | LFE-OUT | Audio bass output |
| 7 | GND | Ground |
| 8 | SPDIF | S/PDIF input |
| 9 | KEY | NC |
| 10 | SPDFO | S/PDIF output |

S-Bracket Cable (optional)

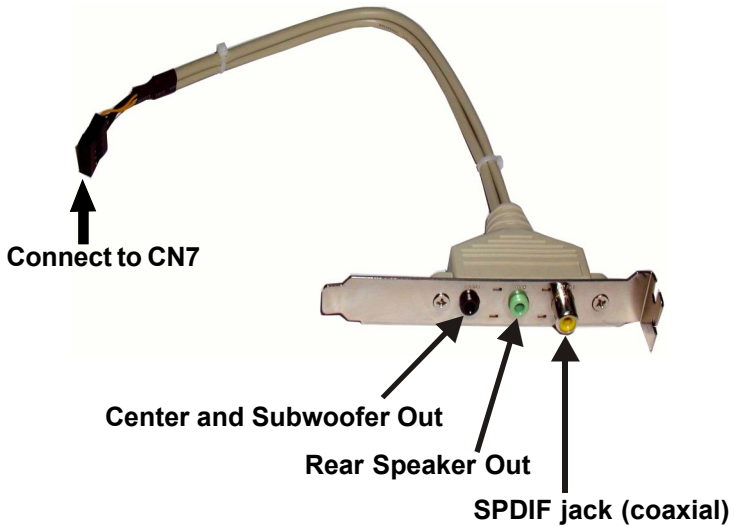

Fan Power Connectors: CPUFAN/SYSFAN

The CPUFAN (processor fan), SYSFAN (system fan) support system cooling fan with +12V. It supports three-pin head connector. When connecting the wire to the connectors, always take note that the red wire is the positive and should be connected to the +12V, the black wire is Ground and should be connected to GND. If the mainboard has a System Hardware Monitor chipset on-board, you must use a specially designed fan with speed sensor to take advantage of the CPU fan control.

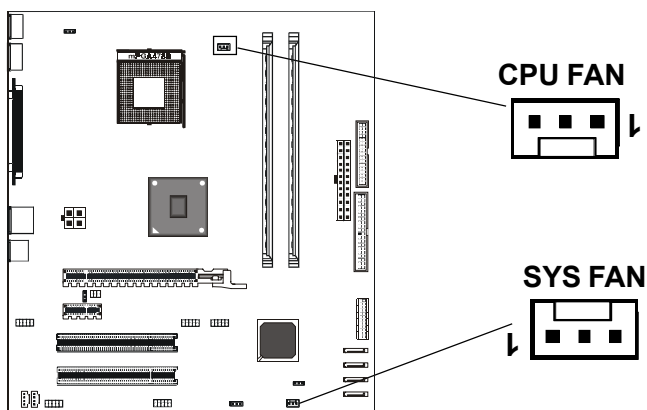

AUX-IN Connector: AUX1 (optional)

The connector is for Audio Device.

CD-IN Connector: CDS1

The connector is for CD-ROM Drive.

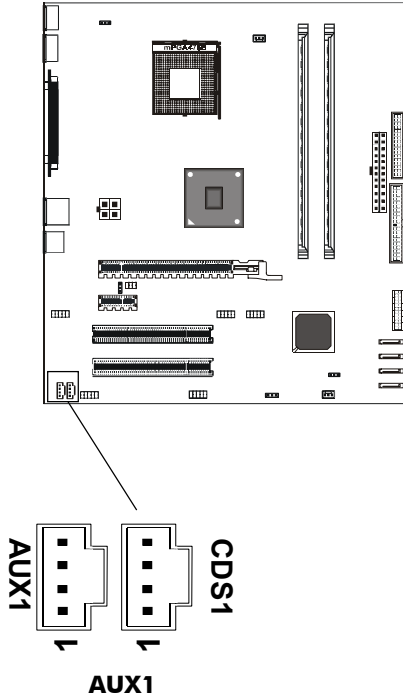

| PIN | Assignment |
|-----|------------|
| 1 | AUX-L |
| 2 | GND |
| 3 | GND |
| 4 | AUX-R |

CDS1

| PIN | Assignment |
|-----|------------|
| 1 | CD-L |
| 2 | GND |
| 3 | GND |
| 4 | CD-R |

Serial ATA Hard Disk Connectors: SATA1/SATA2/SATA3 /SATA4 (optional)

The mainboard has 4 SATA connectors. The mainboard provides optional dual high-speed Serial ATA interface ports, SATA1, SATA2, SATA3&SATA4. Each supports 1st generation serial ATA data rates of 150 MB/s. Both connectors are fully compliant with Serial ATA 1.0 specifications. Each Serial ATA connector can connect to 1 hard disk device. Please refer to Serial ATA Raid manual for detail software installation procedure.

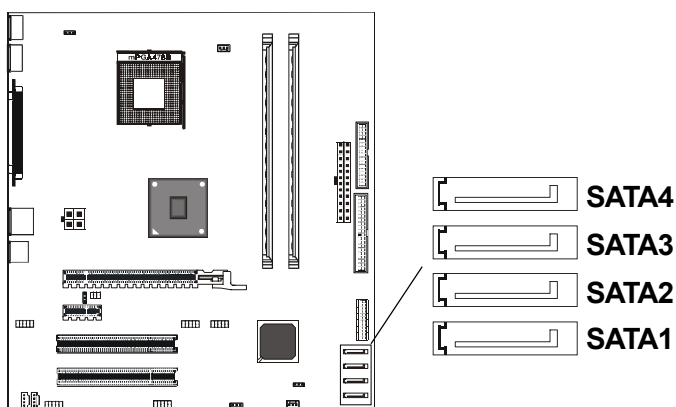

| PIN | SIGNAL |
|-----|--------|
| 1 | GND |
| 2 | TXP |
| 3 | TXN |
| 4 | GND |
| 5 | RXN |
| 6 | RXP |
| 7 | GND |

Serial ATA Cable



Connect one end of the SATA cable to the mainboard, and connect another end to the SATA Hard Disk.



Please do not fold the serial ATA cable in a 90-degree angle, which will cause the loss of data during the transmission.

Serial ATA Hard Disk Devices Power Cable(optional)

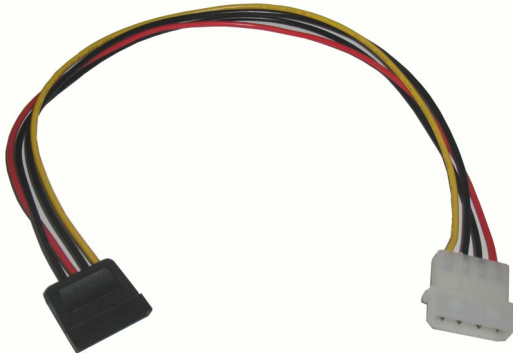

Front Panel Audio Header: FP-S1

This mainboard supports front panel microphone and speaker out ports. If your computer case has these ports, connect them to FP-S1.

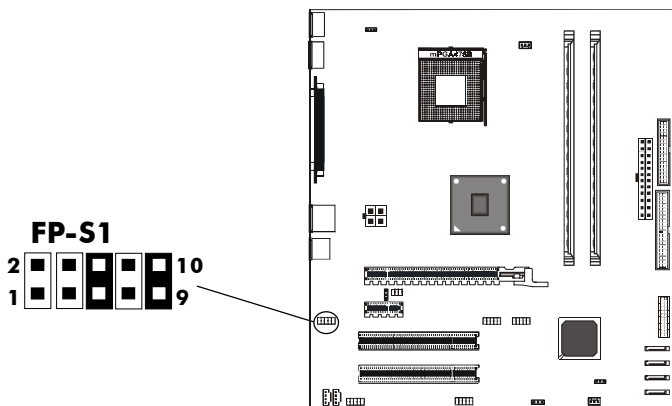

FP-S1

| PIN | Assignment |
|-----|-------------|
| 1 | MIC |
| 2 | GND |
| 3 | REF |
| 4 | POWER |
| 5 | AUD-OUT-R |
| 6 | AUD-RET-R |
| 7 | Reserved |
| 8 | Key(No pin) |
| 9 | AUD-OUT-L |
| 10 | AUD-RET-L |

Note:

If you want to use "Front Audio" connector, you must remove 5-6,9-10 jumper. In order to utilize the front audio header, your chassis must have front audio connector. Also please make sure the pin assignment on the cable is the same as the pin assignment on the MB header. To find out if the chassis you are buying support front audio connector, please contract your dealer.

IEEE 1394 Connector: CN9 (optional)

The mainboard provides one 1394 pin headers that allow you to connect IEEE 1394 ports.

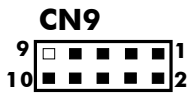
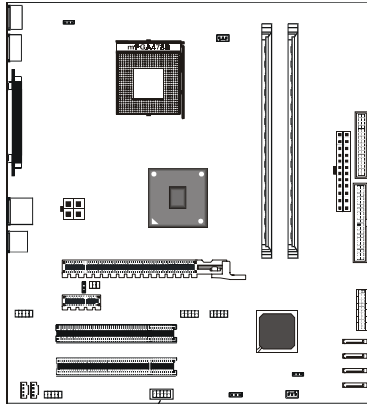

IEEE1394 Pin Definition

| PIN | SIGNAL |
|-----|--------------|
| 1 | TPA+ |
| 2 | TPA- |
| 3 | Ground |
| 4 | Ground |
| 5 | TPB+ |
| 6 | TPB- |
| 7 | Cable power |
| 8 | Cable power |
| 9 | Key (no pin) |
| 10 | Ground |

IEEE 1394 Cable (optional)

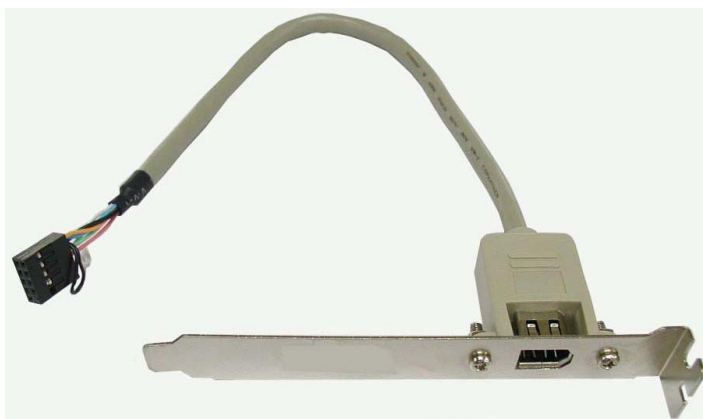

USB Connectors: FP-U1/FP-U2

This mainboard has USB ports. Some computer cases have a special module that mounts USB ports at the front of the case. If you have this kind of case, use auxiliary USB connectors FP-U1/FP-U2 to connect the front mounted ports to the mainboard.

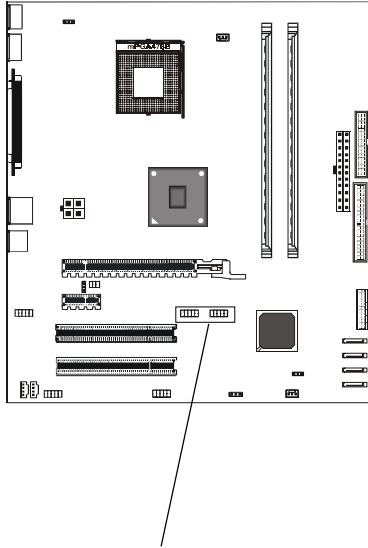

FP-U1/FP-U2

| PIN | Assignment |
|-----|------------|
| 1 | VCC |
| 2 | VCC |
| 3 | USBP0- |
| 4 | USBP1- |
| 5 | USBP0+ |
| 6 | USBP1+ |
| 7 | GND |
| 8 | GND |
| 9 | KEY |
| 10 | OC# |

Front Panel Header: FP1

The mainboard provides one front panel connector.

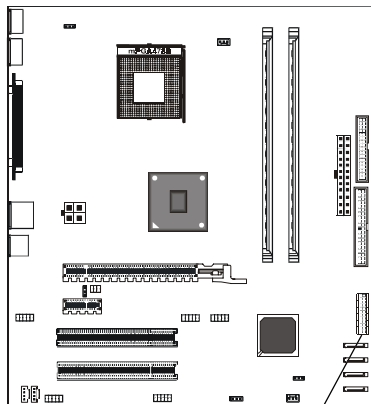

FP1

| | | | | |
|---------|----|---|----|----------|
| | 24 | ■ | 23 | VCC |
| KEYLOCK | 22 | ■ | 21 | GND |
| KEY | 20 | □ | 19 | NC |
| KEY | 18 | □ | 17 | SPEAKER |
| IRRX | 16 | ■ | 15 | IRTX |
| GND | 14 | ■ | 13 | VCC |
| KEY | 12 | □ | 11 | NC |
| KEY | 10 | □ | 9 | NC |
| GND | 8 | ■ | 7 | RESET |
| PWR_SW | 6 | ■ | 5 | GND |
| PW_LED- | 4 | ■ | 3 | HDD_LED- |
| PW_LED+ | 2 | ■ | 1 | HDD_LED+ |

Jumper Setting

This chapter explains how to configure the motherboard's hardware. Before using your computer, make sure all jumpers and DRAM modules are set correctly. Refer to this chapter whenever in doubt.

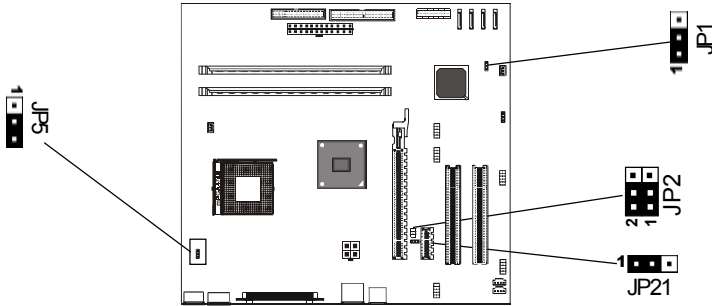

JP1 - CMOS Clear

| JP1 | Selection |
|------|------------|
| 1-2* | Normal* |
| 1-3 | CMOS Clear |

Keyboard Power Select Jumper: JP5

| JP5 | Select |
|------|------------------------|
| 2-3* | Powered by +5V* |
| 1-2 | Powered by +5V Standby |

CPU Frequency Jumper: JP2/JP21 (optional)

| JP2, JP21 | CPU Frequency |
|----------------------------|----------------------------------|
| (2-4)* (1-3)* (1-2)* | Auto* |
| (OPEN) (3-5) (2-3) | 100MHz (for FSB 100 CPU support) |
| OPEN (3-5) (1-2) | 133MHz |
| (4-6) (OPEN) (1-2) | 200MHz |

Close

Open

* = Default setting.

Slots

The motherboard provides one PCIEX16 slot , one PCIEX1 slots and two 32-bit PCI bus slots.

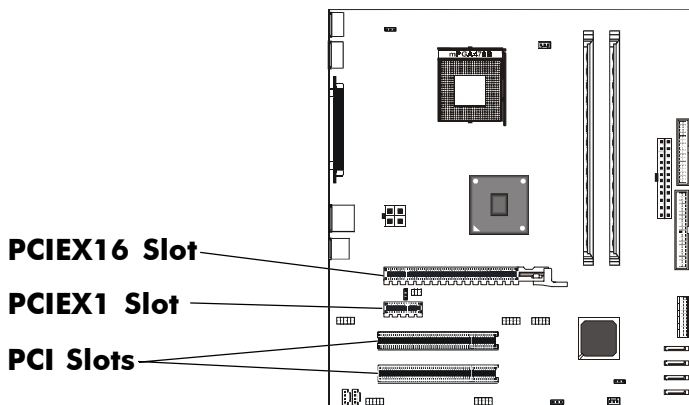

PCI (Peripheral Component Interconnect) Slots

The PCI slots allow you to insert the expansion cards to meet your needs. When adding or removing expansion cards, make sure that you unplug the power supply first. Meanwhile, read the documentation for the expansion card to make any necessary hardware or software settings for the expansion card, such as jumpers, switches or BIOS configuration.

CPU Installation

Please refer to the following steps to install the CPU.

1. Please turn off the power and unplug the power cord before installing the CPU. Pull the lever sideways away from the socket. Make sure to raise the lever up to a 90 degree angle.

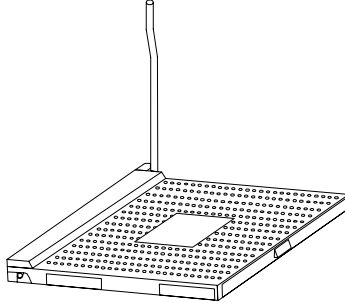

2. Look for the gold arrow. The gold arrow should point towards the lever pivot. The CPU can only fit in the correct orientation.

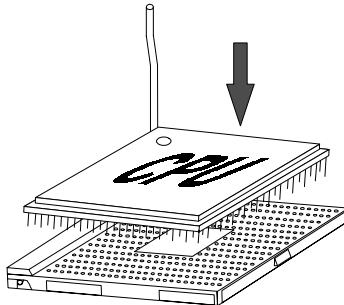

2. If the CPU is correctly installed, the pins should be completely embedded into the socket and can not be seen. Please note that any violation of the correct installation procedures may cause permanent damages to your mainboard.

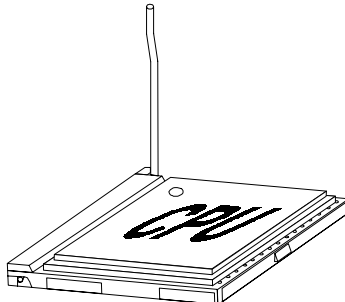

4. Press the CPU down firmly into the socket and close the lever. As the CPU is likely to move while the lever is being closed, always close the lever with your fingers pressing tightly on top of the CPU to make sure the CPU is properly and completely embedded into the socket.

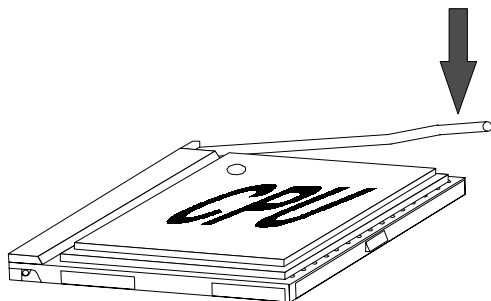

5. Position the CPU cooler set onto the CPU.

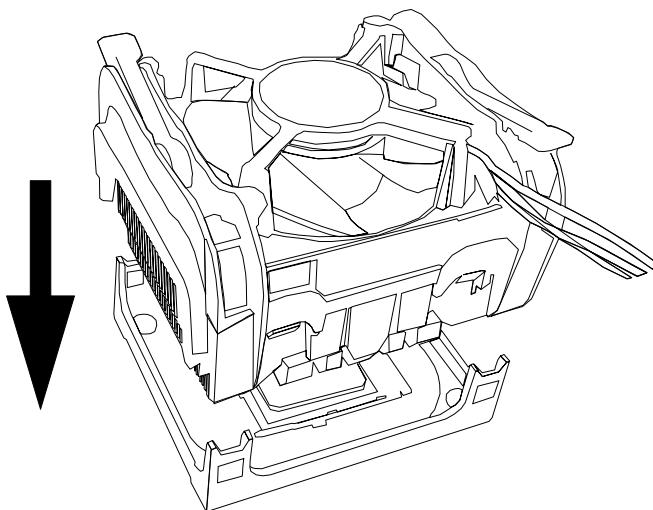

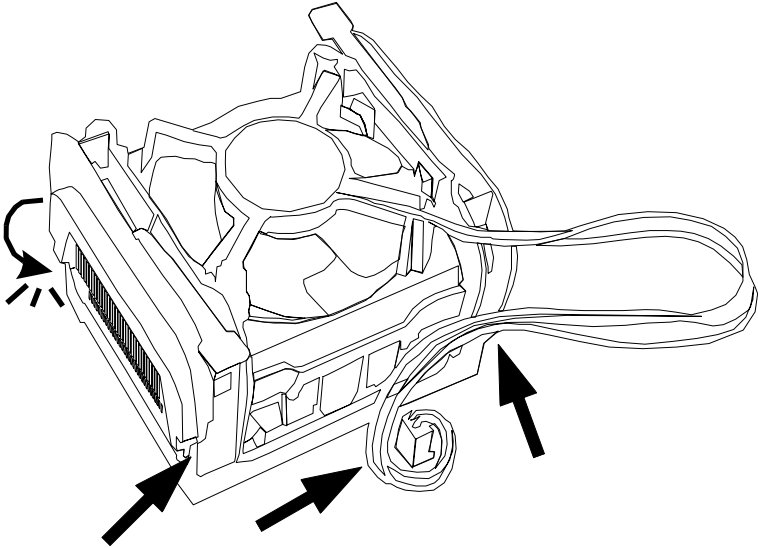

6. Use one end of the clip to hook the latch of the CPU sliding plate and then hook the other three latch to fix the cooling fan set. At last, connect the fan to the power supply connector provided on your mainboard.



When using Prescott CPU, It is recommended that the CPU heat sink should be copper base and with fins radiated to all four directions so that the CPU power generating area can be blown.

Install DDR DIMMs

Please follow the following step to install DDR DIMMs.

1. Locate the DDR DIMM sockets.
2. Holding the DDR DIMM by the edges, remove it from its antistatic package.
3. Make sure the clips at either end of the socket are pushed away from the socket.

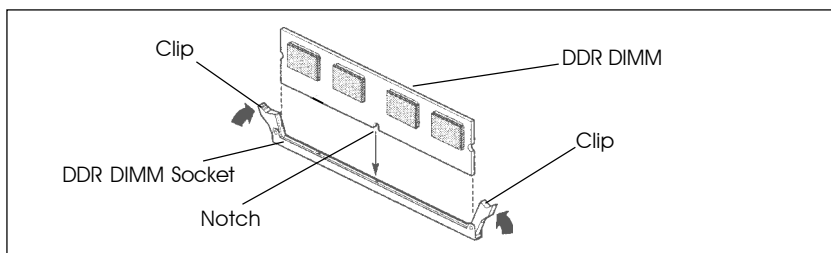

4. Position the DDR DIMM above the socket. Align the two small notches in the bottom edge of the DDR DIMM with the keys in the socket.
5. Insert the bottom edge of the DDR DIMM into the socket.
6. When the DDR DIMM is seated, push down on the top edge of the DDR DIMM until the retaining clips at the ends of the socket snap into place. Make sure the clips are firmly in place.



Please turn off system before installing and removing any device, otherwise you'll cause the system damage.

Memory Configurations

Single Channel Mode

- **Single Channel Population**

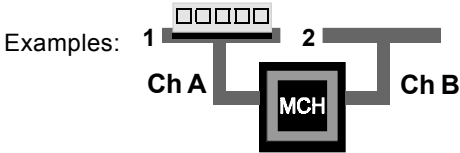

- **Non-identical DIMM or Non-Symmetrical Population**

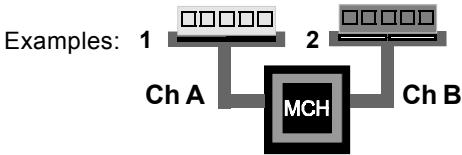
**Note:**

Memory channel speed determined by slowest DIMM populated in system.

Single Channel Mode with Single DIMM, Non-Symmetrical Population or Non-Identical DIMMs.

Dual Channel Mode

- Two DIMM Symmetrical Population

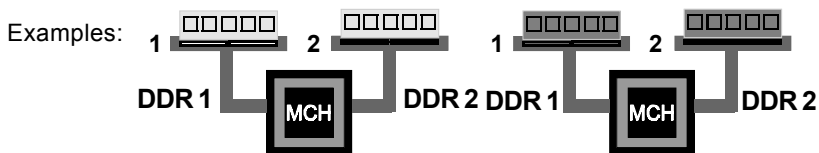

- Symmetrical DIMMs must be identical for optimal performance
 - Same DIMM density, eg 128MB, 256MB, 512MB, etc.
 - Same DRAM Technology, eg 128M-bit.
 - Same DRAM bus width, eg x8 or x16
 - Single Side or Dual Side

Dual Channel Mode with Two Identical DIMMs Populated Symmetrically.

BIOS Setup

This chapter discusses Award's Setup Program built into the ROM BIOS. The Setup Program allows users to modify the basic system configuration. This special information is then stored in battery-backed RAM, which retains the setup information when the power is turned off.

Starting Setup

The Award BIOS is immediately activated when you turn on the computer. The BIOS reads the system information contained in the CMOS and begins the process of checking out the system and configuring it. When it finishes, the BIOS will seek an operating system on one of the disks and then launch and turn control over to the operating system.

While the BIOS is in control, the Setup Program can be activated :

1. By pressing immediately after switching the system on, or
2. By pressing the key when the following message appears briefly at the bottom of the screen during the POST (Power On Self Test)

Press DEL to enter SETUP

If the message disappears before you can respond and you still wish to enter Setup, restart the system to try again by turning it OFF then ON or pressing the "RESET" button on the system case. You may also restart by simultaneously pressing the <Ctrl>, <Alt>, and <Delete> keys. If you do not press the keys at the correct time and the system does not reset, an error message will be displayed and you will again be asked to ...

PRESS F1 TO CONTINUE, DEL TO ENTER SETUP

Getting Help

Press F1 to pop up a small help window that describes the appropriate keys to use and the possible selections for the highlighted item. To exit the Help Window press <Esc> or the F1 key again.

In Case of Problems

If, after making and saving system changes with the Setup Program, you discover that your computer does not reset, use the Award BIOS defaults to override the CMOS settings.

Main Menu

Once you enter the Award BIOS CMOS Setup Utility, the Main Menu will appear on the screen. The Main Menu allows you to select from various setup functions and two exit choices. Use the arrow keys to select among the items and press <Enter> to accept and enter the sub-menu.

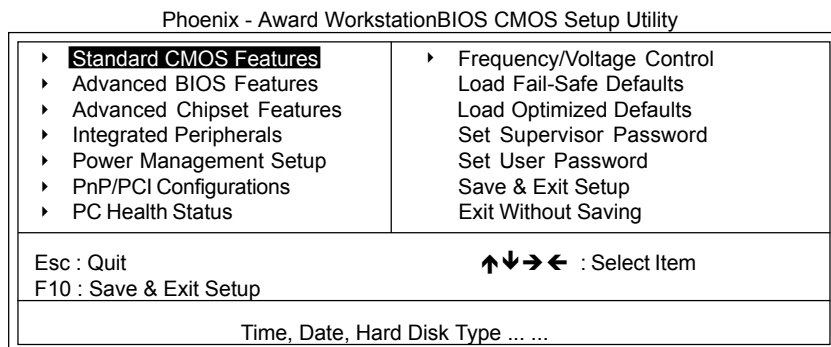

(Note : The figures of BIOS Setup Menu included here only show a typical case, and may not be exactly the same as the one on your unit.)

Note that a brief description of each highlighted item will appear at the bottom of the screen.

Standard CMOS Features This setup page includes all the items of Award™ special standard features.

Advanced BIOS Features This setup page includes all the items of Award™ special enhanced features.

Advanced Chipset Features This setup page includes all the items of chipset special features.

Integrated Peripherals This section page includes all the items of IDE hard drive and Programmed Input / Output features.

Power Management Setup This entry only appears if your system supports Power Management "Green PC" standards.

PNP/PCI Configurations This entry appears if your system supports PNP/PCI.

PC Health Status Display CPU and Case Fan Speed etc.

Frequency/Voltage Control CPU speed setting are settings of CPU speed. You should refer to your CPU marking.

- Load Optimized Defaults** The chipset defaults are settings which provide for maximum system performance. While Award has designed the custom BIOS to maximize performance, the manufacturer has the right to change these defaults to meet its needs.
- Set Supervisor/User Password** Changes, sets, or disables password. It allows you to limit access to the system and the Setup Program.
- Save & Exit Setup** Saves value changes to CMOS and exits setup.
- Exit Without Saving** Abandons all CMOS value changes and exits setup.

Standard CMOS Features

The items in Standard CMOS Setup Menu are divided into 10 categories. Each category includes one or more setup items. Use the arrow keys to highlight the item and then use the <PgUp> or <PgDn> key to select the desired value in each item.

Phoenix - Award WorkstationBIOS CMOS Setup Utility Standard CMOS Features

| | | Item Help |
|------------------------|-----------------------|--|
| Date (mm :d :yy) | Thu. Jan 01 2004 | |
| Time (h h :mm:ss) | 11 : 1 : 35 | |
| ▶ IDE Primary Master | [Press Enter 4303 MB] | Menu Level ▶ |
| ▶ IDE Primary Slave | [None] | Change the day, month, year and century |
| ▶ IDE Secondary Master | [None] | |
| ▶ IDE Secondary Slave | [None] | |
| Drive A | [1.44M, 3.5 in.] | |
| Drive B | [None] | |
| Video | [EGA/VGA] | |
| Halt on | [All, but keyboard] | |
| Base Memory | 640K | |
| Extended Memory | 30720K | |
| Total Memory | 31744K | |

↑↓→←Move Enter: Select +/-/PU/PD : Value F10 : Save ESC : Exit F1 :General Help
F5 : Previous Values F6 : Fail-Safe Defaults F7 : Optimized Defaults

(Note : The figures of BIOS Setup Menu included here only show a typical case, and may not be exactly the same as the one on your unit.)

| | |
|--|---|
| Date | The date format is <day-of-the-week>. <month> <day> <year>. |
| Time | The time format is <hour> <Minute> <second> displayed in 24-hour military-time clock. For example, 1 p. m. is displayed as 13:00:00. |
| Primary Master/Primary Slave/Secondary Master/Secondary | These categories identify the types of the two channels that have been installed in the computer. If the controller of the HDD interface is SCSI, the selection shall be "None". |
| Drive A Type / Drive B Type | This category identifies the types of floppy disk drive A or drive B that has been installed in the computer. |
| Video | The default setting is EGA/VGA. |
| Halt on | You can select which type of error will cause the system to halt. |

Advanced BIOS Features

This section allows you to configure your system for basic operation. You have the opportunity to select the system's default speed, boot-up sequence, keyboard operation, shadowing and security.

Advanced Chipset Features

The Chipset Features Setup option is used to change the values of the chipset registers. These registers control most of the system options in the computer.

This section allows you to configure the system based on the specific features of the installed chipset. This chipset manages bus speeds and access to system memory resources, such as DRAM and the external cache. It must be stated that these items should not be altered. The default settings have been chosen because they provide the best operating conditions for your system.

Integrated Peripherals

The Integrated Peripherals Setup allows the user to configure the onboard IDE controller, floppy disk controller, the printer port and the serial ports.

Power Management Setup

The Power Management Setup Menu allows you to configure your system to most save energy while operating in a manner consistent with your own style of computer use.

PNP/PCI Configurations

This section describes how to configure the PCI bus system. This section covers some very technical items and it is recommended that only experienced users should make any changes to the default settings.

PC Health Status

The PC Health Status display CPU and Case Fan Speed.

Frequency/Voltage Control

This section allows you to set CPU Speed.

Set Supervisor/User Password

You can set either supervisor or user password, or both of them. The difference between them are:

Supervisor Password : You can enter the Setup Program and change the options of the setup menus.

User Password : You can enter the Setup Program but can not change the options of the setup menus.

When you select this function, the following message will appear at the center of the screen to assist you in creating a password.

ENTER PASSWORD:

Type the password, up to eight characters in length, and press<Enter>. The new password will clear the previously entered password from the CMOS memory. You will be asked to confirm the password. Type the password again and press <Enter>. You may also press <Esc> to abort the selection and operate without a password.

To disable a password, just press <Enter> when you are prompted to enter the password. A message will be displayed to confirm that the password is disabled.

PASSWORD DISABLED.

Once the password is disabled, the system will reset and you can enter the Setup Program freely.

When a password is enabled, you will be prompted to enter it every time you try to enter setup. This prevents an unauthorized person from changing any setting of your system configuration.

In addition, when a password is enabled, you can require the BIOS to request a password every time your system is rebooted. This would further prevent unauthorized use of your computer.

The password requirement is defined by the Security Option of the BIOS Features Setup Menu. If the Security Option is set to "System", the password will be required both at resetting and at entering setup. If the option is set to "Setup", the prompt only appears when you try to enter setup.

Flash Update Procedure

A program AWDFLASH.EXE is included in the utility diskette or CD (X:\Utility\AWDFLASH.EXE). The user is recommended to follow the procedure below to update the flash BIOS.

(X: your CD driver letter).

1. Create a DOS-bootable floppy diskette. Copy the new BIOS file (just obtained or downloaded) and the utility program AWDFLASH.EXE to the diskette.
2. Allow the PC system to boot from the DOS diskette.
3. At the DOS prompt, key in

AWDFLASH
and hit <ENTER>

4. Enter the file name of the new BIOS.
5. The question: "Do you want to save BIOS (Y/N)?" is displayed.

Key in "N" if there is no need to save the existing BIOS content..

Key in "Y" if a backup copy of the existing BIOS is needed.

(A file name has to be assigned to the existing BIOS binary file.)

6. The message : "press"Y" to program or "N" to exit" is displayed.

Key in "Y"

7. Wait until the flash-update is completed.
8. Power down the PC system.
9. Restart the PC.

Warning:

DO not turn off or RESET the computer during the flash process.

If you are unsure how to upgrade the BIOS, it is best to take your computer to an Authorized Service Center and have a trained technician do the work for you.

APPENDIX

Note to User:

The bundled driver CD attached an Auto-Run feature for all the drivers that the motherboard need. Please select the drivers that you want to install and click the button on the installation panel.