



## Electronic Emission Notices

### Federal Communications Commission (FCC) Statement

This equipment has been tested and found to comply with the limits for a Class B digital device, pursuant to Part 15 of FCC Rules. These limits are designed to provide reasonable protection against harmful interference in a residential installation. This equipment generates, uses and can radiate radio frequency energy and, if not installed and used in accordance with instructions contained in this manual, may cause harmful interference to radio and television communications. However, there is no guarantee that interference will not occur in a particular installation.

If this equipment does cause harmful interference to radio or television reception, which can be determined by turning the equipment off and on, the user is encouraged to try to correct the interference by one or more of the following measures:

- REORIENT OR RELOCATE THE RECEIVING ANTENNA
- INCREASE THE SEPARATION BETWEEN THE EQUIPMENT AND THE RECEIVER
- CONNECT THE EQUIPMENT INTO AN OUTLET ON A CIRCUIT DIFFERENT FROM THAT OF THE RECEIVER
- CONSULT THE DEALER OR AN EXPERIENCED AUDIO/TELEVISION TECHNICIAN

**NOTE:** Connecting this device to peripheral devices that do not comply with Class B requirements, or using an unshielded peripheral data cable, could also result in harmful interference to radio or television reception.

The user is cautioned that any changes or modifications not expressly approved by the party responsible for compliance could void the user's authority to operate this equipment.

To ensure that the use of this product does not contribute to interference, it is necessary to use shielded I/O cables.

### Copyright

This manual is copyrighted with all rights reserved. No portion of this manual may be copied or reproduced by any means.

While every precaution has been taken in the preparation of this manual, no responsibility for errors or omissions is assumed. Neither is any liability assumed for damages resulting from the use of the information contained herein.

### Trademarks

All brand names, logos and registered trademarks mentioned are property of their respective owners.

---

## Table of Contents

<b>HARDWARE CONFIGURATION .....</b>	<b>5</b>
Key Features .....	5
<b>MOTHERBOARD LAYOUT .....</b>	<b>8</b>
<b>REAR PANEL .....</b>	<b>9</b>
<b>CONNECTORS AND HEADERS .....</b>	<b>11</b>
Floppy Disk Drive Connector - CN3 .....	11
IDE Connectors - CN1&CN2 .....	11
CN1 (Primary IDE Connector) .....	11
CN2 (Secondary IDE Connector) .....	11
IEEE 1394 Header - J23, J24 .....	12
Fan Power Header - CPUFAN, SYSFAN .....	13
CD-IN Header - J30 .....	13
AUX-IN Header - J31 .....	13
Front Panel Audio Header - FP_S1 .....	14
USB Header - FP_U1, FP_U2 .....	15
Front Panel Header - FP1 .....	15
Serial ATA Hard Disk Connectors - SATA1, SATA2, SATA3, SATA4 .....	16
Chassis Alarm Lead - JP12 .....	17
SPDIF Header - J29 .....	17
<b>JUMPER SETTING .....</b>	<b>18</b>
CMOS Clear - JP9 .....	18
On Board AC97 Sound Select - JP14 .....	18
On Board LAN Select - JP13 .....	18
On Board IEEE1394 Select - JP3 .....	18
<b>SLOTS .....</b>	<b>19</b>
<b>CPU INSTALLATION .....</b>	<b>20</b>
<b>MEMORY CONFIGURATIONS .....</b>	<b>22</b>
DDR DIMM Sockets Location .....	22
Install DDR DIMMs .....	23
Memory Configurations .....	23
<b>CrossFire Setup .....</b>	<b>24</b>
Enter CMOS Setup Utility to Set CrossFire .....	24

Installing Driver .....	24
<b>SATA RAID Setup .....</b>	<b>26</b>
Driver and RAID Software Installation .....	27
<b>BIOS SETUP .....</b>	<b>28</b>
About the Setup Utility .....	28
The Standard Configuration .....	28
Entering the Setup Utility .....	28
Press DEL to enter SETUP .....	29
BIOS Navigation Keys .....	29
Updating the BIOS .....	29
Using BIOS .....	30
Standard CMOS Features .....	30
IDE Devices .....	31
Advanced BIOS Features .....	32
Hard Disk Boot Priority .....	33
Advanced Chipset Features .....	35
DRAM Configuration .....	35
LDT & PCI Bus Control .....	36
Integrated Peripherals .....	37
South OnChip IDE Device .....	37
South OnChip PCI Device .....	38
Power Management Setup .....	40
PNP/PCI Configurations .....	42
PC Health Status .....	43
Load Fail-Safe Defaults .....	44
Load Optimized Defaults .....	44
Set Supervisor/User Password .....	45
Save & Exit Setup .....	45
Exit Without Saving .....	45
<b>REALTEK HD AUDIO DRIVER SETUP .....</b>	<b>46</b>
Getting Started .....	46
Sound Effect .....	46
Environment Simulation .....	46
Equalizer Selection .....	47
Frequently Used Equalizer Setting .....	47
Karaoke Mode .....	47
Mixer .....	48
Playback control .....	48
Recording control .....	49
Audio I/O .....	50
Speaker Configuration .....	51

---

Global Connector Settings .....	52
S/PDIF .....	53
Speaker Calibration .....	53
Microphone .....	54
Noise Suppression .....	54
Beam Forming .....	54
Acoustic Echo Cancellation .....	54
Audio Demo .....	55
Information .....	55
<b>BIOS UPDATE PROCEDURE .....</b>	<b>56</b>

---

# HARDWARE CONFIGURATION

## Key Features :

### Chipset

- ATI® RD480+SB450 Chipset.

### Processor

- Support for AMD™ K8 Processor in a Socket939 package.
- Support Hypertransport interface bus.

### VRM (Voltage Regulator Modules) on Board

- Flexible motherboard design with on board VRM, easy to upgrade with future AMD™ K8 processors.
- 0.800V to 1.55V in 25mV steps.

### System Memory

- A total of four 184-pin DDR RAM sockets.
- DIMM size support from 64MB to 4GB.
- Support of dual channel 128-bit wide memory interface.
- Support of 266/333/400 DDR RAM memory type.

### System BIOS

- PnP, APM, ATAPI and Windows® 2000/XP.
- Full support of ACPI & DMI.
- Auto detects and supports LBA harddisks with capacities over 160GB.
- Easy to upgrade BIOS.

### Plug and Play

- Supports Plug and Play specification 1.1.
- Plug and play for Windows®2000 and XP.
- Fully assignable PCI interrupts.

### Onboard I/O

- Onboard two PCI fast IDE ports supporting up to four ATA, ATA2 , Ultra ATA33/66/100/133 IDE HDDs, CD-ROMs, ZIP drives and LS-120 drives as boot drive.
  - One floppy port supports two FDD of 360KB, 720KB, 1.2MB , 1.44MB and 2.88MB capacity.
  - Eight USB ports (four ports via two headers)
  - PS/2 keyboard connector
  - PS/2 mouse connector
  - One front panel sound connector
-

**Extended USB Support**

- Includes 4 OHCI host controllers, increasing the number of external ports to eight.
- Includes 2 OHCI USB2.0 host controller that supports all eight ports (Bandwidth shared between eight ports).
- This motherboard support USB 2.0 feature only on Windows ® 2000 (with SP4 or above) and XP (with SP1 or above) OS.

**Onboard Marvell 88E8052 PCI Express Gigabit LAN (optional)**

- Full compliance with IEEE 802.3u 100 Base-T specifications and IEEE 802.3X Full Duplex Flow Control.
- Supports 10 Mb/s, 100 Mb/s and 1000 Mb/s operation.
- Supports Wake-On-LAN function and remote wake-up.

**On-board Realtek RTL8100C PCI LAN (optional)**

- Provides 32-bit performance, PCI bus master capability.
- Full compliance with IEEE 802.3u 100 Base-T specifications and IEEE 802.3X Full Duplex Flow Control.
- Supports Wake-On-LAN function and remote wake-up.

**PCI Express x16 Graphics Interface**

- Two 16-lane (x16 port) PCI Express port intended for external graphics.
- Fully compliant to the PCI Express Base Specification revision 1.0a.
- The base PCI Express frequency of this interface is 4GB/s.
- PCI Express supports an enhanced addressing mechanism.
- Support ATI CrossFire (optional).

**PCI Express x1 Ports**

- Two 1-lane (x1 port) PCI Express port intended for external graphics.
- Fully compliant to the PCI Express Base Specification revision 1.0a.
- Two virtual channel support for full unsynchronized data transfers.
- Supports full 2.5Gb/s bandwidth in each direction per x1 lane.

**Power Management**

- Supports SMM, APM and ACPI.
- Break switch for instant suspend/resume on system operations.
- Energy star "Green PC" compliant.
- Hardware monitoring circuit is supported, provide voltage, fan speed, etc. monitoring.
- Wake-On-LAN (WOL) support.
- Supports Suspend-To-RAM (STR).

***Please use 300 watt power supply or above.***

---

**Onboard ALC880 7.1 Audio**

- Integrated Realtek ALC880 controller.
- Fully Sound and Sound Blaster compatible.
- Full-Duplex 4 24-bit two-channel DACs and 3 stereo 20-bit ADCs.
- PnP and APM 1.2 support.
- Windows® 2000/XP drivers ready.
- Line-in, Line-out, Mic-in, SPDIF-in, SPDIF-out.
- Supports ALC880 codec for eight channel sound output.

**Onboard IEEE1394 (optional)**

- Compliant with IEEE 1394 OHCI specifications v1.0 and v1.1.
- Integrated 400Mb 2-port PHY.

**Onboard Serial ATA Host Controller**

- Independent DMA operation on four ports.
- Data transfer rates of 150MB/s.
- RAID 0/1 feature support .

**Expansion Slots**

- 2 PCI Express X16 slot.
- 2 PCI Express X1 slots.
- 3 PCI bus master slots - ver. 2.2 compliant.



Static electricity can harm delicate components of the motherboard. To prevent damage caused by static electricity, discharge the static electricity from your body before you touch any of the computer's electronic components.

## MOTHERBOARD LAYOUT

The following diagram shows the relative positions of the jumpers, connectors, major components and memory banks on the motherboard.

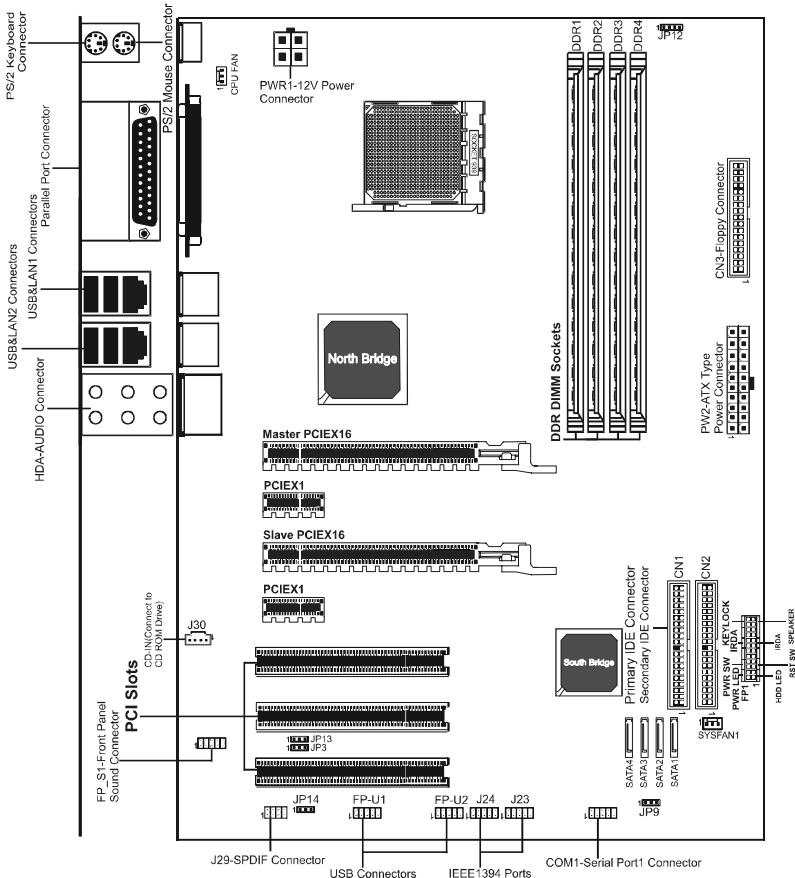

- NOTE : 1)** Be sure to check the HDD cable orientation in order to match the colored strip to the pin1 end of the connector.
- 2) When you start up the system, please wait for 5 seconds after you power on AC.
  - 3) It is not recommended to add a metal spacer plate on the back of the Socket939. Otherwise, some components will be short and damaged.



## REAR PANEL

The back panel provides the following connectors:

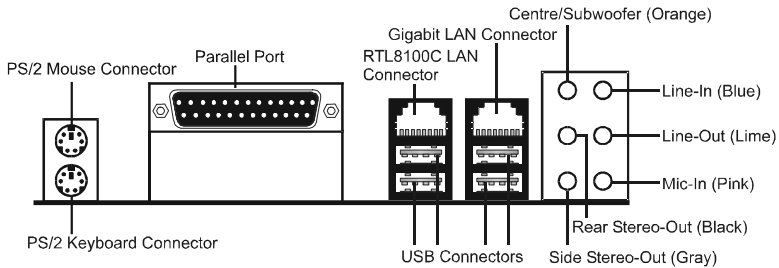

### PS/2 Mouse Connector

The motherboard provides a standard PS/2 mouse mini DIN connector for attaching a PS/2 mouse. You can plug a PS/2 mouse directly into this connector.

### PS/2 Keyboard Connector

The motherboard provides a standard PS/2 keyboard mini DIN connector for attaching a PS/2 keyboard. You can plug a PS/2 keyboard directly into this connector.

### USB 2.0 Connector

The motherboard provides a OHCI (Open Host Controller Interface) Universal Serial Bus root for attaching USB devices such as keyboard, mouse or other USB-compatible devices. You can plug the USB device directly into the connector.

### USB 2.0 Connector

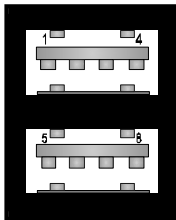

### USB 2.0 - Pin Definition

PIN	SIGNAL	DESCRIPTION
1	VCC	+5V/5VSB (optional)
2	-Data 0	Negative Data Channel 0
3	+Data0	Positive Data Channel 0
4	GND	Ground
5	VCC	+5V/5VSB (optional)
6	-Data 1	Negative Data Channel 1
7	+Data 1	Positive Data Channel 1
8	GND	Ground

**LAN Jacks Connectors (Optional)**

The mainboard provides two standard RJ-45 jacks for connection to Local Area Network(LAN).You can connect the network cable to the LAN jack.

**Gigabit LAN**

The onboard Marvell 88E8052 PCI-E X1 controller supports 10/100/1000 Mb/s operations.

**8 Channel HD Audio**

Option select of 2, 6, or 8 channel audio from onboard ALC880 High Definition audio compliant CODEC with 20-bit ADC and 24-bit DAC resolution.

- Support CD-In, SPDIF-in and SPDIF-out.
- Optical & Coaxial SPDIF-out available on rear panel.
- Support jack detection for easy audio device installation.

**Rear panel audio jacks configuration:**

<b>Audio Jack Color</b>	<b>2 Channel</b>	<b>6 Channel</b>	<b>8 Channel</b>
<b>Blue</b>	Line-In	Line-In	Line-In
<b>Lime</b>	Line-Out	Front Stereo-Out	Front Stereo-Out
<b>Pink</b>	Mic-In	Mic-In	Mic-In
<b>Gray</b>	--	--	Side Stereo-Out
<b>Black</b>	--	Rear Stereo-Out	Rear Stereo-Out
<b>Orange</b>	--	Centre & Subwoofer	Centre & Subwoofer

---

## CONNECTORS AND HEADERS

The motherboard provides connectors to connect to FDD, IDE HDD, USB Ports and CPU/System FAN etc.

### Floppy Disk Drive Connector - CN3

The motherboard provides a standard floppy disk drive connector that supports 360K, 720K, 1.2M, 1.44M and 2.88M floppy disk types.

### IDE Connectors - CN1&CN2

The motherboard has a 32-bit Enhanced PCI IDE and Ultra DMA 33/66/100/133 controller that provides PIO mode 0-4, Bus Master, and Ultra DMA 33/66/100/133 function. You can connect up to four hard disk drives, CD-ROM, 120MB Floppy (reserved for future BIOS) and other devices.

### Primary IDE Connector - CN1

The first hard drive should always be connected to CN1. CN1 can connect a Master and a Slave drive. You must configure second hard drive to Slave mode by setting the jumper accordingly.

### Secondary IDE Connector - CN2

CN2 can also connect a Master and a Slave drive.

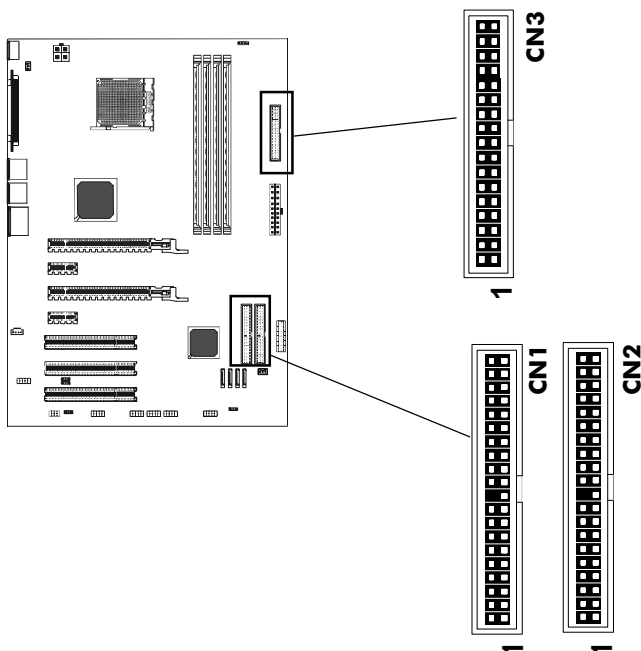

**IEEE 1394 Header - J23/J24**

The motherboard provides four 1394 pin headers that allow you to connect IEEE 1394 ports.

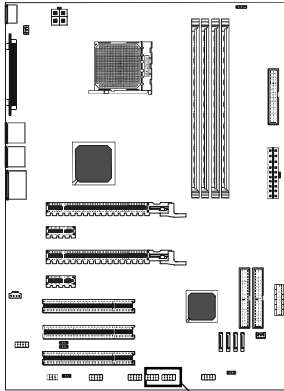

**J24/J23 - Pin Definition**

PIN	SIGNAL
1	TPA+
2	TPA-
3	Ground
4	Ground
5	TPB+
6	TPB-
7	Cable power
8	Cable power
9	Key (no pin)
10	Ground

**J24**

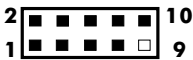

**J23**

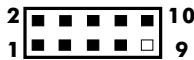

**IEEE 1394 Cable**



### Fan Power Header - CPUFAN, SYSFAN

The CPUFAN (processor fan), SYSFAN (system fan) support system cooling fan with +12V. It supports three-pin head connector.

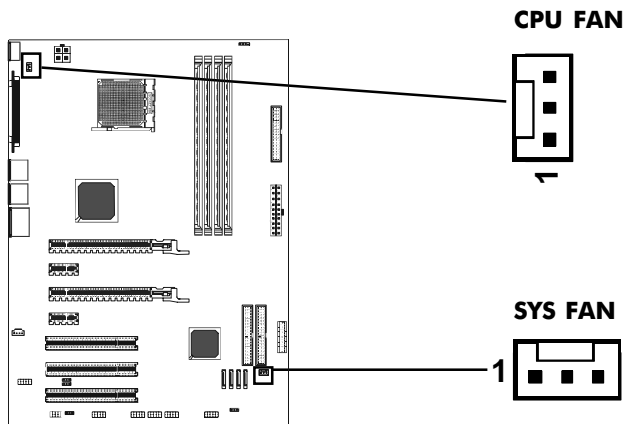

### CD-IN Header - J30

This header allows for connection of audio from CD-ROM drive.

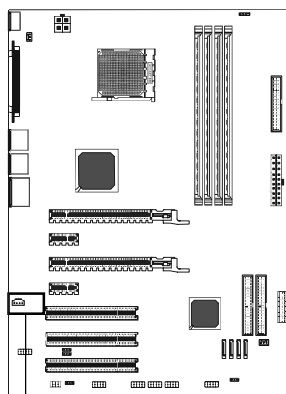

### J30

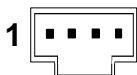

### J30 - Pin Definition

PIN	SIGNAL
1	CD-L
2	GND
3	GND
4	CD-R

Front Panel Audio Header - FP\_S1

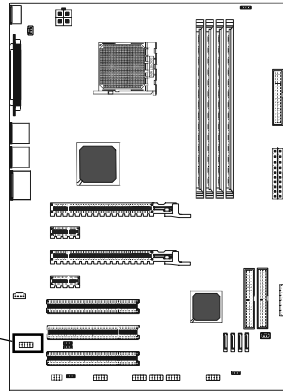
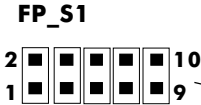

FP\_S1 - Pin Definition

Pin	Signal	Description
1	PORT 1L	Analog Port1 - Left channel
2	GND	Ground
3	PORT 1R	Analog Port 1 - Right channel
4	PRESENCE	Active low signal - signals BIOS that a High Definition Audio dongle is connected to the analog header. PRESENCE=0 when a High Definition Audio dongle is connected.
5	PORT 2R	Analog Port 2 - Right channel
6	SENSE1_RETIRN	Jack detection return from front panel JACK1
7	SENSE_SEND	Jack detection sense line from the High Definition Audio Codec jack detection resistor network
8	KEY	Connector Key
9	PORT 2L	Analog Port2 - Left channel
10	SENSE2_RETIRN	Jack detection return from front panel JACK2

*Note: In order to utilize the front audio header, your chassis must have a front audio connector. Also please make sure the pin assignment on the cable is the same as the pin assignment on the motherboard header. To find out if the chassis you are buying supports front audio connection, please contact your dealer.*

## USB Header - FP\_U1, FP\_U2

This motherboard has up to eight USB ports. Some computer cases have a special module that mounts USB ports at the front of the case. If you have this kind of case, use auxiliary USB connector FP\_U1/FP\_U2 to connect the front mounted ports to the motherboard.

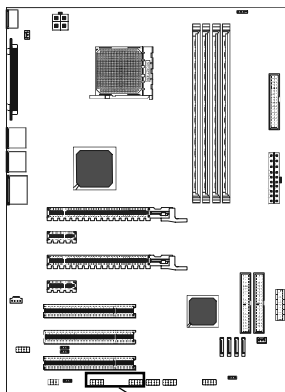

## FP\_U1, FP\_U2 - Pin Definition

PIN	SIGNAL
1	VCC
2	VCC
3	USBP0-
4	USBP1-
5	USBP0+
6	USBP1+
7	GND
8	GND
9	KEY
10	OC#

### FP\_U1



### FP\_U2

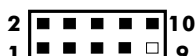

## Front Panel Header - FP1

The motherboard provides a front panel connection to the front panel switches and LEDs. FP1 is compliant with the Front Panel I/O Connectivity Design Guide.

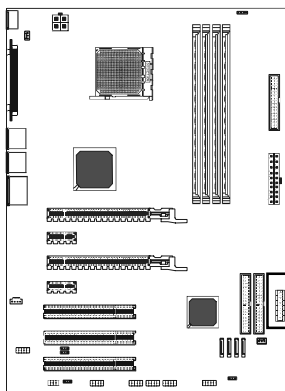

## FP1

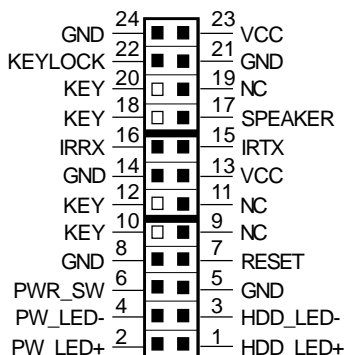

**Serial ATA Hard Disk Connectors - SATA1, SATA2, SATA3, SATA4**

The motherboard has four SATA connectors: SATA1, SATA2, SATA3, SATA4. Each supports 1<sup>st</sup> generation SATA data rates of 150 MB/s. All connectors are fully compliant with Serial ATA 1.0 specifications. Each SATA connector can connect to one hard disk device. Please refer to SATA Raid Setup (p.25) for details on software installation procedure.

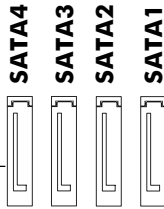
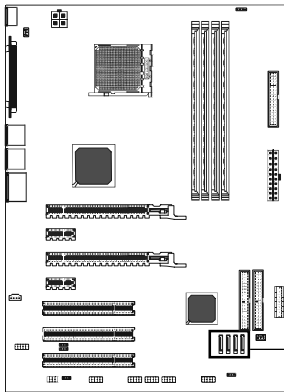

**SATA1, SATA2, SATA3, SATA4 - Pin Definition**

PIN	SIGNAL
1	GND
2	TXP
3	TXN
4	GND
5	RXN
6	RXP
7	GND

**Serial ATA Cable**

This cable is compatible for use with SATA and SATA-II devices.



Serial ATA Cable



Serial ATA Devices  
Power Cable (optional)

 CAUTION!	Please do not fold the serial ATA cable, which may lead to loss of data during transmission.
--------------	--



### Chassis Alarm Lead - JP12(optional)

This lead is for a chassis designed with intrusion detection feature.this requires an external detection mechanism such as a chassis intrusion sensor or microswitch.When you remove any chassis component,the sensor triggers and sends a high-level signal to this lead to record a chassis intrusion event.

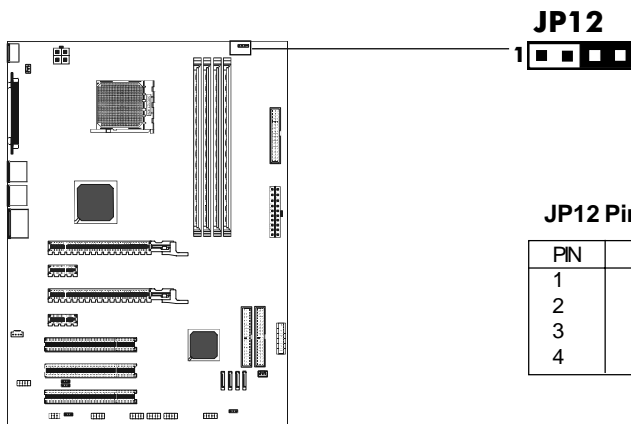

#### JP12 Pin Definition

PIN	Assignment
1	+5VSB
2	KEY
3	Chassis Signal
4	GND

#### Note:

If you want to use “Chassis Alarm” Connector, you must remove 3-4 jumper.

### SPDIF Header - J29

This header provides a SPDIF (Sony/Philips Digital Interface) output to digital multimedia device through fiber or coaxial connector.

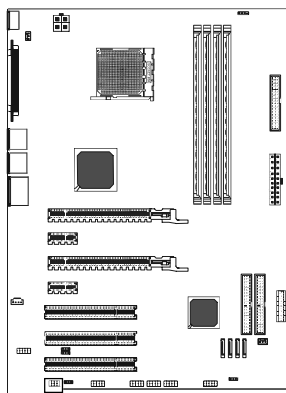

#### J29 Pin Definition

PIN	Assignment
1	SPDIF_INX
2	SPDIF_OUTX

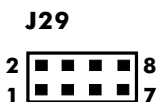

## JUMPER SETTING

The motherboard provides jumpers enabling configuration of the motherboard's hardware.

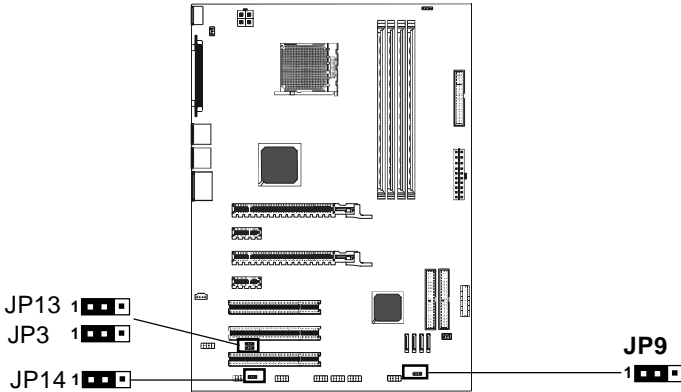

### Clear CMOS Jumper - JP9

If you want to clear the system configuration, use the JP9 (Clear CMOS Jumper) to clear data.

JP9	Selection
1-2*	Normal*
1-2 2-3	CMOS Clear

### JP14-On Board AC97 Sound Select



JP14	Function
1-2*	AC97 Sound Enable*
1-2 2-3	AC97 Sound Disable

### JP13-On Board RTL8100C LAN Select(optional)

JP13	Function
1-2*	LAN Enable*
1-2 2-3	LAN Disable

### JP3-On board IEEE1394 Select (optional)

JP3	Selection
1-2*	IEEE1394 Enable*
1-2 2-3	IEEE1394 Disable

 Close
  Open
 \* = Default setting.

## SLOTS

The motherboard provides two PCI-E x16 slot, two PCIe x1 slot and three 32-bit PCI bus slots.

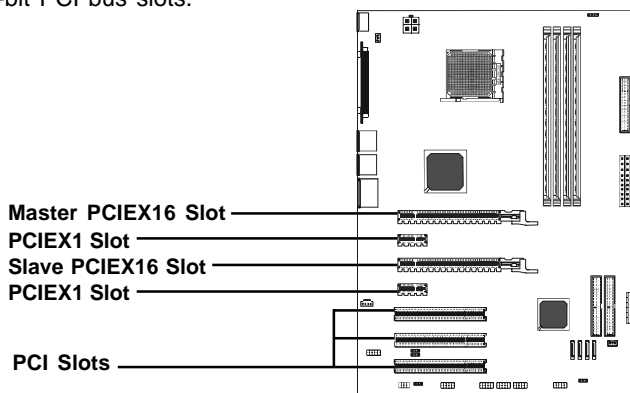

### PCI Express x16 Graphics Interface

- Two 16-lane (x16 port) PCI Express port intended for external graphics.
- Fully compliant to the PCI Express Base Specification revision 1.0a.
- The base PCI Express frequency of this interface is 4GB/s.
- PCI Express supports an enhanced addressing mechanism.
- Support ATI CrossFire.

**Note:** This motherboard is bundled with a PCIEX16 Adapter, if you want to use one PCIEX16 graphic card only, please insert the bundled PCIEX16 Adapter to Slave PCIEX16 slot simultaneously.

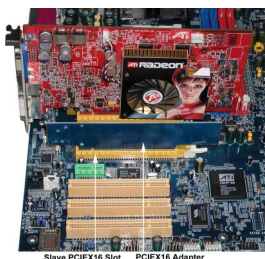

### PCI Express x1 Ports

- Two 1-lane (x1 port) PCI Express ports intended for external graphics.
- Fully compliant to the PCI Express Base Specification revision 1.0a.
- Two virtual channel support for full unsynchronized data transfers.
- Supports full 2.5Gb/s bandwidth in each direction per x1 lane.

### PCI (Peripheral Component Interconnect) Slots

- Three 32-bit PCI ports for add-in card connections.

## CPU INSTALLATION

Please refer to the following steps to install the CPU.

1. Please turn off the power and unplug the power cord before installing the CPU. Pull the lever slightly sideways away from the socket to unlock the lever, and then raise the lever up to a full 90 degree angle.

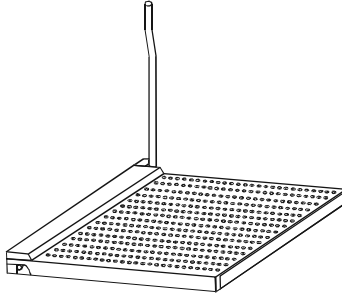

2. Look for the gold arrow. The gold arrow should point towards the lever pivot. The CPU can only fit in the correct orientation and requires no excessive force.

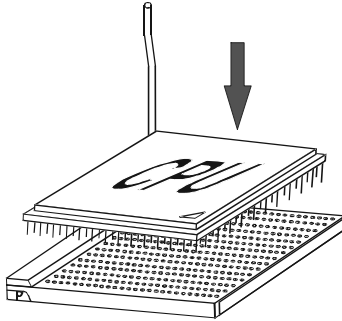

3. If the CPU is correctly installed, the pins should be completely embedded into the socket allowing for no gaps inbetween CPU and socket. Please note that any violation of the correct installation procedures may cause permanent damage to your motherboard.

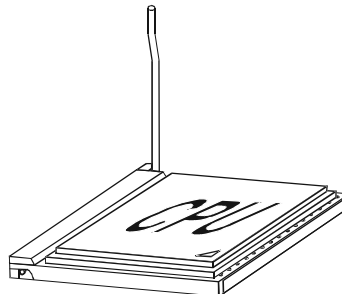

4. Press the CPU down firmly into the socket and close the lever. As the CPU is likely to move while the lever is being closed, always close the lever with your fingers pressing firmly on top of the CPU to make sure the CPU is properly and completely embedded into the socket.

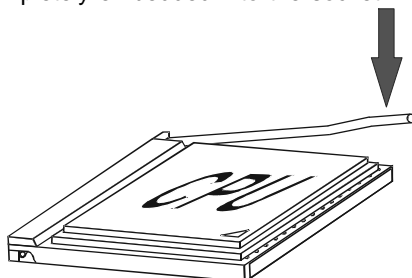

5. When you are installing the CPU, please make sure the CPU has a heatsink and a cooling fan attached on the top to prevent overheating. If you do not have a heatsink or cooling fan, contact your dealer to purchase and install them before turning on the computer. Please follow below steps to install the CPU cooler.

#### Step 1.

Position the cooler onto the retention mechanism. Hook one end of the clip first, and then press down the other end of the clip to fasten the cooler onto the top of the retention module.



#### Step 2.

Locate the Fixed Lever on the side of the cooler and lift the lever upwards.



Step 3.  
Fasten down the lever.

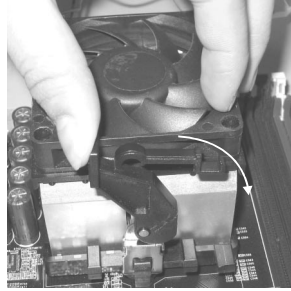

Step 4.  
Make sure the safety hook  
completely clasps the fixed bolt  
of the retention module.



## MEMORY CONFIGURATIONS

### DDR DIMM Sockets Location

Please refer to the following figure for the location of the DDR DIMM Sockets.

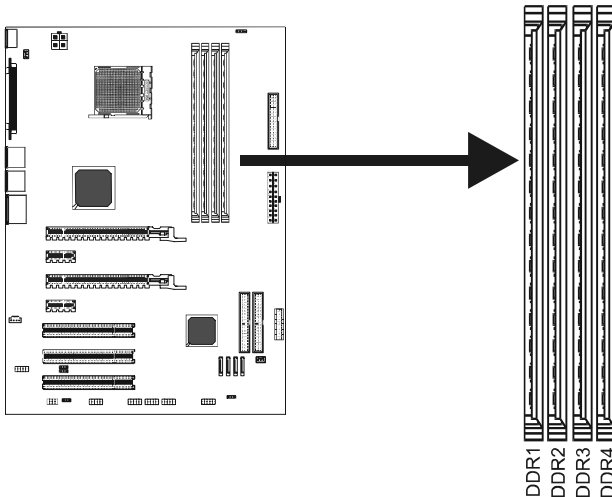

## Install DDR DIMMs

Please follow the below mentioned steps to install DDR DIMMs.

1. Hold the DDR DIMM module by the edges and remove it from its antistatic package.
2. Make sure the clips at either end of the DIMM socket are pushed away from the socket.

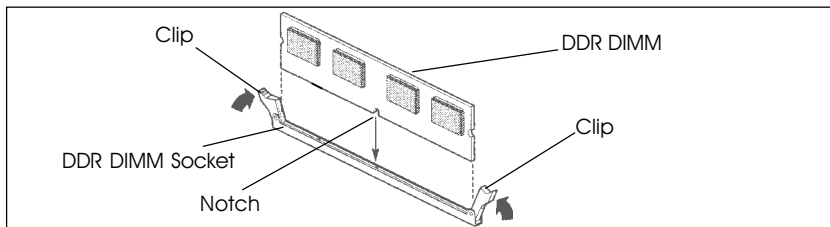

3. Position the DDR DIMM module above the socket and align the notch in the bottom edge of the module with the key in the socket.
4. Insert the bottom edge of the DDR DIMM module into the socket.
5. When the module is seated, press down on the top edge of the DDR DIMM module until the retaining clips at the ends of the socket snap into place.

**Note:** Please unplug the power supply before installing and removing any device, otherwise you may cause the system damage.

## Memory Configurations

Please refer to the following recommended memory configurations.

Mode / (DIMM Type)	Case	Sockets			
		DDR1	DDR2	DDR3	DDR4
Single-channel / (DDR400/DDR333/DDR266)	1*	Populated	----	----	----
	2*	----	----	Populated	----
Dual-channel / (DDR400/DDR333/DDR266)	1#	Populated	Populated	----	----
	2#	----	----	Populated	Populated
	3#	Populated	Populated	Populated	Populated

- \* When using only one DDR DIMM, insert the DDR DIMM into DDR1 or DDR3 socket.
- \* You can install a pair of identical DIMMs in DDR1 and DDR2 and another pair of identical DIMMs in DDR3 and DDR4.

**Note:**

- In dual channel mode, always install an identical (the same type and size) DDR DIMM pair in sockets.
- It is not recommended to use a three DIMM configuration.
- Memory channel speed is determined by slowest DIMM populated in system.

## CrossFire SETUP

If you want to set up the CrossFire, the Master card should be inserted to Master slot and the Slave card should be inserted to Slave slot properly. Make sure that the card is inserted in correct slot.

### Enter CMOS Setup Utility to set CrossFire

1. Press <Del> Key during POST.
2. Scroll to “Advance Chipset Features”, press enter.
3. Set the “Dual Slot Configuration” to “Enable”, and the “GFX0 Link Width” and “GFX1 Link Width” are set to “x8”.

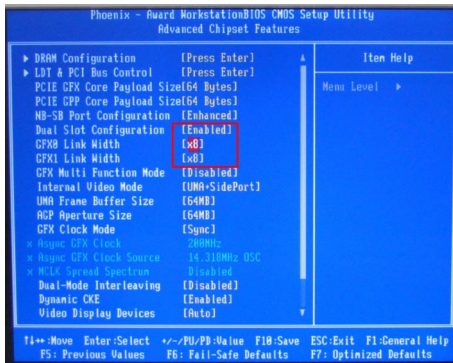

4. Press F10 to Save and Exit.

### Installing Driver

After setting up the Windows, you need to install the 8.15 driver or later which must be included the Catalyst Control Centre (CCC).



### Step1



In the CCC advanced mode, you need to click the check box to enable the CrossFire.

Click "Standard View" as default



Step 2

Click "CrossFire™"

Step3

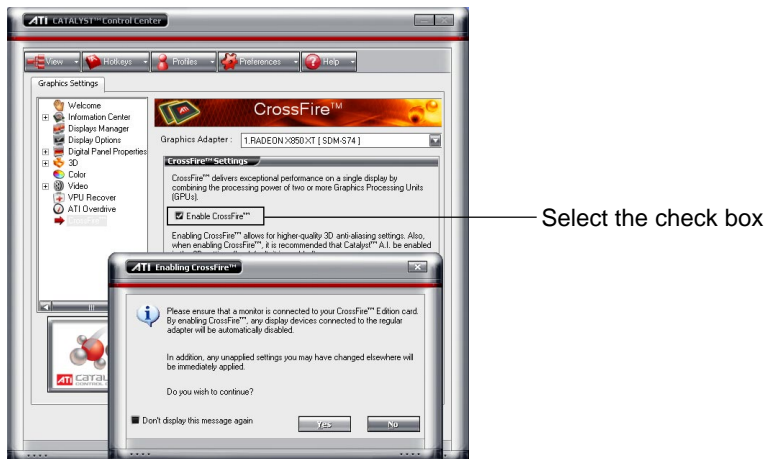

Select the check box

Step4

After the CrossFire is enable, it means that the CrossFire is set up successfully, you can see that the CrossFire has now started.

## SATA RAID SETUP

Creating and deleting RAID sets is a function found in the RAID utility. During bootup, the following message will appear, pausing for a few seconds to allow the user to enter the RAID utility:

**Press Ctrl+S or F4 to enter RAID utility**

An easy-to-use screen will appear with the following choices:

**Create RAID Set   Delete RAID Set   Rebuild RAID Set   Resolve Conflicts**

Below this will be a list of drives currently installed on the system.

### Creating RAID Sets

SATA Raid supports two drives. Please follow the below mentioned steps.

1. Select "Create RAID Set" and choose either a "Striped" or "Mirrored" RAID Set.
2. Select if you want the utility to Auto Configure the RAID Set or if you want to manually configure the RAID Set. For Striped Sets, you can change the chunk size. For Mirrored Sets, you can assign Source and Target drives, as well as if you want Disk Copy.

**What is a Striped RAID Set?** Also known as RAID Level 0, a Striped RAID Set allows for high speed storage without redundancy. This requires 2 identical drives allowing for data to be split across the drives resulting in faster data throughput. Choose this selection if you want to gain performance.

**What is a Mirrored RAID Set?** Also known as RAID Level 1, a Mirrored RAID Set allows for both high speed storage and redundancy. This requires 2 identical drives allowing for data to be copied from a source drive and duplicated onto the second drive. Choose this selection if you prefer security options to prevent data loss.

**What is a Disk Copy?** In the case where you have a drive that already contains data and you would like to create a new RAID Set, you will need to purchase an identical drive and select Disk Copy to allow the contents of your source drive to be copied to your new destination drive.

### Deleting RAID Sets

1. To remove one or more RAID sets, select "Delete RAID Set."
2. Select desired set and press Y when asked "Are You Sure?"

### Rebuilding RAID Sets

In case your RAID set has encountered an error or it has been changed, you can recover the RAID set using this option.

## Resolving Conflicts

When a RAID set is created, the metadata is written to the disk includes drive connection information (Primary Channel, Secondary Channel). If, after a disk failure, the replacement disk was previously part of a RAID set (or used in another system), it may have conflicting metadata, specifically in reference to the drive connection information. If so, this will prohibit the RAID set from being either created or rebuilt. In order for the RAID set to function properly, this old metadata must be first overwritten with the new metadata. To resolve this, select "Resolve Conflict" and the correct metadata, including the correct drive connection information, will be written to the replacement disk.

## Driver and RAID Software Installation

1. For Windows 2000 and XP, after Windows has finished booting up, the system will automatically find the newly installed adapter and prompt the **Found New Hardware Wizard** window. Click **Cancel** to skip it.



2. Insert the bundled driver CD DISC into your CD-ROM drive, select "**ATI Chipset\ATI\_Raid Driver**" installation bar on the dialogue Window to begin the driver and software installation. (Please follow the instruction to finish the installation).

When you install a new Windows 2000 or XP operating system on your RAID set, please follow the below procedure:

1. Insert the bundled driver CD DISC into CD-ROM(D:).  
Copy all files from directory ( D:\ATI chipset\ATI\_Raid ) to a floppy disk.
2. Install OS from CD-ROM.
3. Press "**F6**" when display "Press **F6** if you need to install a third party SCSI or RAID driver..."
4. Insert floppy disk.
5. Choose the OS device driver wanted for loading.
6. Install OS.
7. Install driver after OS is installed.

## BIOS SETUP

### About the Setup Utility

The computer uses the latest Award BIOS with support for Windows Plug and Play. The CMOS chip on the motherboard contains the ROM setup instructions for configuring the motherboard BIOS.

The BIOS (Basic Input and Output System) Setup Utility displays the system's configuration status and provides you with options to set system parameters. The parameters are stored in battery-backed-up CMOS RAM that saves this information when the power is turned off. When the system is turned back on, the system is configured with the values you stored in CMOS.

The BIOS Setup Utility enables you to configure:

- Hard drives, diskette drives and peripherals**
- Video display type and display options**
- Password protection from unauthorized use**
- Power Management features**
- Overclocking features**

The settings made in the Setup Utility affect how the computer performs. Before using the Setup Utility, ensure that you understand the Setup Utility options.

This chapter provides explanations for Setup Utility options.

### The Standard Configuration

A standard configuration has already been set in the Setup Utility. However, we recommend that you read this chapter in case you need to make any changes in the future.

This Setup Utility should be used:

- when changing the system configuration
- when a configuration error is detected and you are prompted to make changes to the Setup Utility
- when trying to resolve IRQ conflicts
- when making changes to the Power Management configuration
- when changing the password or making other changes to the Security Setup

### Entering the Setup Utility

When you power on the system, BIOS enters the Power-On Self Test (POST) routines. POST is a series of built-in diagnostics performed by the BIOS. After the POST routines are completed, the following message appears:

## Press DEL to enter SETUP

Pressing the delete key accesses the BIOS Setup Utility:

Phoenix - Award Workstation BIOS CMOS Setup Utility	
<ul style="list-style-type: none"> <li>▶ Standard CMOS Features</li> <li>▶ Advanced BIOS Features</li> <li>▶ Advanced Chipset Features</li> <li>▶ Integrated Peripherals</li> <li>▶ Power Management Setup</li> <li>▶ PnP/PCI Configurations</li> <li>▶ PC Health Status</li> </ul>	<ul style="list-style-type: none"> <li>▶ Frequency/Voltage Control</li> <li>Load Fail-Safe Defaults</li> <li>Load Optimized Defaults</li> <li>Set Supervisor Password</li> <li>Set User Password</li> <li>Save &amp; Exit Setup</li> <li>Exit Without Saving</li> </ul>
Esc: Quit :	↑↓→←: Select Item
F10: Save & Exit Setup	
Time, Date, Hard Disk Type...	

**(Note : The figures of BIOS Setup Menu included here only show a typical case, and may not be exactly the same as the one on your unit.)**

## BIOS Navigation Keys

The BIOS navigation keys are listed below:

KEY	FUNCTION
↑↓→←	Move
Enter	Select item or option
+/-/PU/PD	Value
ESC	Exit
F1	Display the General Help
F5	Restore the Previous Values
F6	Load the Fail-Safe Defaults
F7	Load the Optimized Defaults
F10	Save configuration

## Updating the BIOS

You can download and install updated BIOS for this motherboard from manufacturer's web site. New BIOS provides support for new peripherals, improvements in performance, or fixes for known bugs. Install new BIOS as follows:

1. Create a bootable system disk. (Refer to Windows online help for information on creating a bootable system disk.)
2. Download the Flash Utility and new BIOS file from the manufacturer's Web site. Copy these files to the system diskette you created in Step 1.
3. Turn off your computer and insert the system diskette in your computer's diskette drive. (You might need to run the Setup Utility and change the boot priority items on the Advanced BIOS Features Setup page, to force your computer to boot from the floppy diskette drive first.) Also see page 56 for more information.
4. At the A:\ prompt, type the Flash Utility program name and press <Enter>.

5. Type the filename of the new BIOS in the “File Name to Program” text box. Follow the onscreen directions to update the motherboard BIOS.
6. When the installation is complete, remove the floppy diskette from the diskette drive and restart your computer. If your motherboard has a Flash BIOS jumper, reset the jumper to protect the newly installed BIOS from being overwritten.

**Using BIOS**

When you start the Setup Utility, the main menu appears. The main menu of the Setup Utility displays a list of the options that are available. A highlight indicates which option is currently selected. Use the cursor arrow keys to move the highlight to other options. When an option is highlighted, execute the option by pressing <Enter>.

Some options lead to pop-up dialog boxes that prompt you to verify that you wish to execute the option. Other options lead to dialog boxes that prompt you for information.

Some options (marked with a triangle ▶) lead to submenus that enable you to change the values for the option. Use the cursor arrow keys to move the items in the submenu.

In this manual, default values are enclosed in parenthesis. Submenu items are denoted by a triangle▶ .

**Standard CMOS Features**

This option displays basic information about your system.

Phoenix - Award WorkstationBIOS CMOS Setup Utility  
Standard CMOS Features

Date (mm:dd:yy)	Sun, July 10 2005	Item Help
Time (hh:mm:ss)	23 : 21 : 34	
▶ IDE Channel 0 Master	[ST380021A]	Menu Level ▶ Change the day, month, year and century
▶ IDE Channel 0 Slave	[None]	
▶ IDE Channel 1 Master	[SAMSUNG DVD-ROM SD-6]	
▶ IDE Channel 1 Slave	[GCR-8525B]	
▶ IDE Channel 2 Master	[None]	
▶ IDE Channel 3 Master	[None]	
▶ IDE Channel 4 Master	[None]	
▶ IDE Channel 5 Master	[None]	
Drive A	[1.44M, 3.5 in.]	
Halt On	[All Errors]	
Base Memory	640K	
Extended Memory	260096K	
Total Memory	261120K	

↑↓→←: Move    Enter: Select    +/-/PU/PD: Value    F10: Save    ESC: Exit    F1: General Help  
F5: Previous Values    F6:Fail-Safe Defaults    F7: Optimized Defaults

## Date and Time

The Date and Time shows the current date and time on the computer. If you are running Windows, it is automatically updated whenever you make changes to the Windows Date and Time Properties utility.

## IDE Devices (None)

Your computer has two IDE channels (Primary and Secondary) and each channel can be installed with one or two devices (Master and Slave). Use these items to configure each device on the IDE channel.

Press <Enter> to display the IDE submenu:

Phoenix - Award WorkstationBIOS CMOS Setup Utility  
IDE Channel 0 Master

IDE HDD Auto-Detection	[Press Enter]	Item Help
IDE Channel 0 Master	[Auto]	Menu Level ►►  To auto-detect the HDD's size, head... on this channel
Access Mode	[Auto]	
Capacity	0MB	
Cylinder	0	
Head	0	
Precomp	0	
Lading Zone	0	
Sector	0	

↑↓→←: Move    Enter: Select    +/-/PU/PD: Value    F10: Save    ESC: Exit    F1: General Help  
F5: Previous Values    F6: Fail-Safe Defaults    F7: Optimized Defaults

## IDE HDD Auto-Detection

Press <Enter> while this option is highlighted to prompt the Setup Utility to automatically detect and configure an IDE device on the IDE channel.

**NOTE:** If you are setting up a new hard disk drive that supports LBA mode, more than one line will appear in the parameter box. Choose the line that lists LBA for the LBA drive.

## IDE Channel 0/1 Master/Slave (Auto)

Leave this option at Auto to enable the system to automatically detect and configure IDE devices on the channel. If it fails to find a device, change the value to Manual and then manually configure the drive by entering the characteristics of the drive in the items described below. Refer to your drive's documentation or look on the drive casing if you need to obtain this information. If no device is installed, change the value to None.

**NOTE:** Before attempting to configure a hard disk drive, ensure that you have the configuration information supplied by the manufacturer of your hard drive. Incorrect settings can result in your system not recognizing the installed hard disk.

**Access Mode (Auto)**

This option defines ways that can be used to access IDE hard disks such as LBA (Large Block Addressing). Leave this value at Auto and the system will automatically decide the fastest way to access the hard disk drive.

Press <Esc> to return to the Standard CMOS Features Page

**Drive A (1.44M, 3.5 in./None)**

This option define the characteristics of any diskette drive attached to the system. You can connect one or two diskette drives.

**Halt On (All Errors)**

This option defines the operation of the system POST (Power On Self Test) routine. You can use this item to select which types of errors in the POST are sufficient for you to halt the system.

**Base Memory, Extended Memory, and Total Memory**

These options are automatically detected by the system at startup. They are display-only fields. You cannot make changes to these fields.

**Advanced BIOS Features**

This section defines advanced information about your system.

Phoenix - Award Workstation BIOS CMOS Setup Utility  
Advanced BIOS Features

▶ Hard Disk Boot Priority	[Press Enter]	Item Help
Virus Warning	[Disabled]	Menu Level ▶
CPU Internal Cache	[Enabled]	
External Cache	[Enabled]	Select Hard Disk Boot Device Priority
Quick Power On Self Test	[Enabled]	
First Boot Device	[Floppy]	
Second Boot Device	[Hard Disk]	
Third Boot Device	[LS120]	
Boot Other Device	[Enabled]	
Boot Up Floppy Seek	[Enabled]	
Boot Up NumLock Status	[On]	
Gate A20 Option	[Fast]	
Typematic Rate Setting	[Disabled]	
x Typematic Rate (Chars/Sec0X)	6	
x Typematic Delay (Msec)	250	
Security Option	[Setup]	
APIC Mode	[Enabled]	
MPS Version Control For OS	[1.4]	
OS Select for DRAM > 64MB	[Non-OS2]	

↑↓→←: Move    Enter: Select    +/-/PU/PD: Value    F10: Save    ESC: Exit    F1: General Help  
F5: Previous Values    F6: Fail-Safe Defaults    F7: Optimized Defaults



## Hard Disk Boot Priority

Navigate to this section and press <Enter> to view the following screen:

Phoenix - Award WorkstationBIOS CMOS Setup Utility  
Hard Disk Boot Priority

<pre> 1. Ch0 M.      : ST380021A 2. Bootable Add-in Cards </pre>	<p>Item Help</p> <hr/> <p>Menu Level ▶▶ Use &lt;↑&gt; or &lt;↓&gt; to select a device, then press &lt;+&gt; to move it up, or &lt;-&gt; to move it down the list. Press &lt;ESC&gt; to exit this menu.</p>
--	--

↑↓→←: Move    Enter: Select    +/-/PU/PD: Value    F10: Save    ESC: Exit    F1: General Help  
F5: Previous Values    F6:Fail-Safe Defaults    F7: Optimized Defaults

### Virus Warning (Disabled)

If this function is enabled and someone attempts to write data into this area, BIOS will show a warning message on screen and alarm beep

### CPU Internal Cache (Enabled)

All processors that can be installed in this motherboard use internal level 1 (L1) cache memory to improve performance. Leave this item at the default value for better performance.

### External Cache (Enabled)

Most processors that can be installed in this system use external level 2 (L2) cache memory to improve performance. Leave this item at the default value for better performance.

### Quick Power On Self Test (Enabled)

To allow the system to skip certain tests while booting. This will decrease the time needed to boot the system. You might like to enable this option when you are confident that your system hardware is operating smoothly.

### Third Boot Device (LS120)

Use these three options to select the priority and order of the devices that your system searches for an operating system at start-up time.

### Boot Other Device (Enabled)

When this option enabled, the system searches all other possible locations for an operating system if it fails to find one in the devices specified among the First, Second, and Third boot devices.

### Boot Up Floppy Seek (Enabled)

When this option is enabled, it checks the size of the floppy disk drives at start-up time.

**Boot Up Num Lock Status (On)**

This option defines if the keyboard Num Lock key is active when your system is started, default is on.

**Gate A20 Option (Fast)**

This option defines how the system handles legacy software that was written for an earlier generation of processors.

**Typematic Rate Setting (Disabled)**

If this option is enabled, you can use the following two options to set the typematic rate and the typematic delay settings for your keyboard.

- **Typematic Rate (Chars/Sec):**  
This option defines how many characters per second are generated by a held-down key.
- **Typematic Delay (Msec):**  
This option defines how many milliseconds must elapse before a held-down key begins generating repeat characters.

**Security Option (Setup)**

If you have installed password protection, this option defines if the password is required at system start up or if it is only required when a user tries to enter the Setup Utility.

**APIC Mode (Enabled)**

This option allows you to enable or disable the APIC (Advanced Programmable Interrupt Controller) mode. APIC provides symmetric multiprocessing (SMP) for systems, allowing support for up to 60 processors. It is recommended to enable this option.

**MPS Version Control For OS (1.4)**

This option can improve support for multiple PCI bus configurations and improve future expendability. The default is 1.4.

**OS Select For DRAM > 64 MB (Non-OS2)**

This item is only required if you have installed more than 64 MB of memory and you are running the OS/2 operating system. Otherwise, leave this item at the default.

**HDD S.M.A.R.T Capability (Disabled)**

The S.M.A.R.T. (Self-Monitoring, Analysis, and Reporting Technology) system is a diagnostics technology that monitors and predicts device performance. S.M.A.R.T. software resides on both the disk drive and the host computer. The disk drive software monitors the internal performance of the motors, media, heads and electronics of the drive. The host software monitors the overall reliability status of the drive. If a device failure is predicted, the host software warns the user of the impending condition and advises appropriate actions to protect the data.

## Advanced Chipset Features

These options define critical timing parameters of the motherboard. You should leave the options on this page at their default values unless you are familiar with the technical specification of your system hardware. Changing the values to a incorrect setting may result in fatal errors or may cause your system to run unstable.

### Phoenix - Award WorkstationBIOS CMOS Setup Utility Advanced Chipset Features

		Item Help
▶	DRAM Configuration	[Press Enter]
▶	LDT & PCI Bus Control	[Press Enter]
	PCIE GFX Core Payload Size	[64 Bytes]
	PCIE GPP Core Payload Size	[64 Bytes]
	NB-SB Port Configuration	[Enhanced]
	Dual Slot Configuration	[Enabled]
	GFX0 Link Width	[x8]
	GFX1 Link Width	[x8]
	GFX Multi Function Mode	[Disabled]
	Internal Video Mode	[UMA+SidePort]
	UMA Frame Buffer Size	[64MB]
	AGP Aperture Size	[64MB]
	GFX Clock Mode	[Sync]
x	Async GFX Clock	200MHz
x	Async GFX Clock Source	14.318MHz OSC
x	MCLK Spread Spectrum	Disabled
	Dual-Mode Interleaving	[Disabled]
	Dynamic CKE	[Enabled]
	Video Display Devices	[Auto]
		Menu Level ▶

↑↓→←: Move Enter: Select +/-/PU/PD: Value F10: Save ESC: Exit F1: General Help  
F5: Previous Values F6:Fail-Safe Defaults F7: Optimized Defaults

## DRAM Configuration

Navigate to this section and press <Enter> to view the following screen:

### Phoenix - Award WorkstationBIOS CMOS Setup Utility DRAM Configuration

		Item Help
	Timing Mode	[Auto]
x	Memc LOCK index value (Mhz)	200Mhz
x	CAS# latency (Tcl)	2.5
	MIRR mapping mode	[Continuous]
		Menu Level ▶▶

↑↓→←: Move Enter: Select +/-/PU/PD: Value F10: Save ESC: Exit F1: General Help  
F5: Previous Values F6:Fail-Safe Defaults F7: Optimized Defaults

**Timing Mode (Auto)**

This option allows you to set up the DRAM timing manually or automatically. This item is set to [Auto] by default. When setting to[Manu] the following options are adjustable.

- **Memclock index value (Mhz) (200MHz):** When DDR Timing Setting is set to Manual, use this option to set the DRAM frequency.
- **CAS# latency (Tcl) (2.5):** This option determines the operation of SDRAM memory CAS (column address strobe). It is recommended that you leave this option at the default value. The 2T setting requires faster memory that specifically supports this mode.

**LDT & PCI Bus Control**

Navigate to this option and press <Enter> to view the following screen:  
LDT is the abbreviation for Lightning Data Transport.

Phoenix - Award WorkstationBIOS CMOS Setup Utility  
LDT & PCI Bus Control

LDT Configuration [Enabled] Upstream LDT Bus Width [16 bit] Downstream LDT Bus Width [16 bit] LDT Bus Frequency [Auto] PCIE Reset Delay [Disabled]	Item Help Menu Level ►►
--	----------------------------

↑↓→←: Move    Enter: Select    +/-/PU/PD: Value    F10: Save    ESC: Exit    F1: General Help  
 F5: Previous Values    F6:Fail-Safe Defaults    F7: Optimized Defaults

**LDT Configuration (Enabled)**

This option enables or disables the LDT configuration.

**Upstream LDT Bus Width (16 bit)**

This option allows users to manually adjust the upstream LDT bus width to be 8 bit or 16 bit.

**Downstream LDT Bus Width (16 bit)**

This option allows users to manually adjust the downstream LDT bus width to be 8 bit or 16 bit.

**LDT Bus Frequency (Auto)**

This option allows users to manually adjust the LDT Bus Frequency.

**PCIE Reset Delay (Disabled)**

This item enables or disables the PCIE reset delay.

## Integrated Peripherals

This section displays options that define the operation of peripheral components on the system's input/output ports.

Phoenix - Award WorkstationBIOS CMOS Setup Utility  
Integrated Peripherals

▶ South OnChip IDE Device	[Press Enter]	Item Help
▶ South OnChip PCI Device	[Press Enter]	Menu Level ▶
Init Display First	[PCI Slot]	
Surroundview	[Disabled]	
USB EHCI Controller	[Enabled]	
OnChip USB Controller	[Enabled]	
OnChip USB KBC Controller	[Enabled]	
USB Mouse Support	[Enabled]	
IDE HDD Block Mode	[Enabled]	
Onboard FDC Controller	[Enabled]	
Onboard Serial Port 1	[Auto]	
Onboard Parallel Port	[Disabled]	
x Parallel Port Mode	SPP	
x ECP Mode Use DMA	3	

↑↓→←: Move Enter: Select +/-/PU/PD: Value F10: Save ESC: Exit F1: General Help  
F5: Previous Values F6:Fail-Safe Defaults F7: Optimized Defaults

## South OnChip IDE Device

Navigate to this option and press <Enter> to view the following screen:

Phoenix – Award WorkstationBIOS CMOS Setup Utility  
South OnChip IDE Device

IDE DMA transfer access	[Enabled]	Item Help
OnChip IDE Channel0	[Enabled]	Menu Level ▶▶
OnChip IDE Channel1	[Enabled]	
IDE Prefetch Mode	[Disabled]	
Primary Master	PIO [Auto]	
Primary Slave	PIO [Auto]	
Secondary Master	PIO [Auto]	
Secondary Slave	PIO [Auto]	
Primary Master	UDMA [Auto]	
Primary Slave	UDMA [Auto]	
Secondary Master	UDMA [Auto]	
Secondary Slave	UDMA [Auto]	

↑↓→←: Move Enter: Select +/-/PU/PD: Value F10: Save ESC: Exit F1: General Help  
F5: Previous Values F6:Fail-Safe Defaults F7: Optimized Defaults

### IDE DMA transfer access (Enabled)

This option allows you to enable the transfer access of the IDE DMA. If you disable this function you will only have PIO modes 1-4 available.

### OnChip IDE Channel0/1 (Enabled)

Use this option to enable or disable the PCI IDE channels that are integrated on the motherboard.

### IDE Prefetch Mode (Enabled)

The onboard IDE drive interface supports IDE prefetching for faster drive access. If you install a primary and secondary add-on interface, set this field to Disable if the interface does not support prefetching.

### Primary/Secondary Master/Slave PIO (Auto)

Each IDE channel supports a master device and a slave device. These four items let you assign the kind of PIO (Programmed Input/Output) was used by the IDE devices. Choose Auto to let the system auto detect which PIO mode is best, or select a PIO mode from 0 to 4.

### Primary/Secondary Master/Slave UDMA (Auto)

Each IDE channel supports a master device and a slave device. This motherboard supports UltraDMA technology, which provides faster access to IDE devices. If you install a device that supports UltraDMA, change the appropriate item on this list to Auto.

### IDE HDD Block Mode (Enabled)

Enable this option if your IDE hard drive supports block mode. Block mode enables BIOS to automatically detect the optimal number of block read and writes per sector that the drive can support. It also improves the speed of access to IDE devices.

Press <Esc> to return to the Standard CMOS Features Page

## South OnChip PCI Device

Navigate to this option and press <Enter> to view the following screen:

Phoenix - Award WorkstationBIOS CMOS Setup Utility  
South OnChip PCI Device

Onboard Azalia Audio	[Auto]	Item Help
Onboard Azalia Clock	[UsbClk48]	
Onboard AC97 Audio	[Auto]	Menu Level ▶▶
Onboard MC97 Modem	[Auto]	
OnChip SATA Controller	[Both]	
OnChip SATA Type	[IDE Controller]	
Onboard 1394	[Enabled]	

↑↓→←: Move    Enter: Select    +/-/PU/PD: Value    F10: Save    ESC: Exit    F1: General Help  
F5: Previous Values    F6:Fail-Safe Defaults    F7: Optimized Defaults

**Onboard Azalia AUDIO (Auto)**

This option allows you to control the onboard Azalia (High Definition) audio. Disable this option if you do not need the high definition onboard sound.

**OnChip SATA Controller (Both)**

This option allows you to enable or disable the Serial ATA controller.

**OnChip SATA Type (IDE Controller)**

This option allows you to control the Serial ATA controller as IDE mode or RAID mode.

**Onboard 1394**

This option allows you to enable or disable the onboard IEEE1394 function.

Press <Esc> to return to the Standard CMOS Features Page

**Init Display First**

Use this option to specify whether your graphics adapter is installed in one of the PCI slots.

**OnChip USB Controller (Enabled)**

This option allows you to enable or disable the onboard USB controller.

**OnChip USB KBC Controller (Enabled)**

This option allows you to enable or disable the USB Keyboard support.

**USB Mouse Support (Enabled)**

This option allows you to enable or disable the USB mouse support.

**IDE HDD Block Mode (Enabled)**

Block mode is also called block transfer or multiple sector read/write. If your IDE hard drive supports block mode, select Enabled for automatic detection of the optimal number of block read/write per sector the drive can support.

**Onboard FDC Controller (Enabled)**

Select Enabled if your system has a floppy drive controller (FDC) installing in the system board and you want to use it. If you install add-in FDC or the system has no floppy drive, select Disabled.

**Onboard Serial Port 1 (Auto)**

Select a logical COM port name and matching address for the first and second serial ports. Select an address and corresponding interrupt for the first and second serial ports.

**Onboard Parallel Port (Disabled)**

This option allows you to determine onboard parallel port controller I/O address setting.

---

### Parallel Port Mode (SPP)

Select an operating mode for the onboard parallel (printer) port. Select Normal, Compatible, or SPP unless you are sure your hardware and software both support one of the other available modes.

### ECP Mode Use DMA (3)

Select a DMA channel for the port when you choose ECP or ECP+EPP mode for the Parallel Port Mode.

## Power Management Setup

This option lets you control system power management. The system has various power-saving modes including powering down the hard disk, turning off the video, suspending to RAM, and software power down that allows the system to be automatically resumed by certain events.

Phoenix-Award WorkstationBIOS CMOS Setup Utility  
Power Management Setup

ACPI function	[Enabled]	Item Help
ACPI Suspend Type	[S3(STR)]	
C2 Disable/Enable	[Disabled]	
Power Management Option	[User Define]	Menu Level ▶
HDD Power Down	[Disabled]	
Video Off Option	[Suspend -> Off]	
Video Off Method	[V/H SYNC+Blank]	
MODEM Use IRQ	[3]	
Soft-Off by PWRBTN	[Instant-Off]	
PowerOn by PCI Card	[Disabled]	
PowerFail Status	[HardWare Strap]	
AMD K8 Cool'n'Quite control	[Disable]	
RTC Alarm Resume	[Disabled]	
* Date (of Month)	0	
* Resume Time (hh:mm:ss)	0 : 0 : 0	

↑↓→←: Move    Enter: Select    +/-/PU/PD: Value    F10: Save    ESC: Exit    F1: General Help  
F5: Previous Values    F6:Fail-Safe Defaults    F7: Optimized Defaults

### ACPI function (Enabled)

Select Enabled only if your computer's operating system supports the Advanced Configuration and Power Interface (ACPI) specification.

ACPI Suspend Type (S1&S3)

Use this item to define the suspend mode for your system.



**Power Management Option (User Define)**

This option allows you to select the type (or degree) of power saving for Doze, Standby, and Suspend modes.

- User Define – Select time-out period in the section for each mode stated below.
- Max Saving – Maximum power savings. Inactivity period is 1 minute in each mode.
- Min Saving – Minimum power savings. Inactivity period is 1 hour in each mode(except the hard driver)

**HDD Power Down (Disabled)**

The IDE hard drive will spin down if it is not accessed within a specified length of time. Options are from 1 Min to 15 Min and Disabled.

**Video Off Option (Suspend—> Off)**

This option defines if the video is powered down when the system is put into suspend mode.

**Video Off Method (V/H SYNC+Blank)**

This item defines how the video is powered down to save power.

**MODEM Use IRQ (3)**

If you want an incoming call on a modem to automatically resume the system from a power-saving mode, use this item to specify the interrupt request line (IRQ) that is used by the modem. You might have to connect the fax/modem to the motherboard Wake On Modem connector for this feature to work.

**Soft-Off by PWRBTN (Instant Off)**

Under ACPI (Advanced Configuration and Power management Interface) you can create a software power down. In a software power down, the system can be resumed by Wake Up Alarms. This option lets you install a software power down that is controlled by the power button on your system. If you select Instant-Off, then the power button causes a software power down. If you select Delay 4 Sec. then holding the power button down for four seconds is required to cause a software power down.

**PowerOn by PCI Card (Disabled)**

This options allows the system to be awakened from power saving modes when activity or input signal of the PCI Card is detected.

**AMD K8 Cool'n'Quite control (Disabled)**

This option helps the system to lower the frequency when CPU idles. When the frequency decreases, the temperature will drop automatically as well.

**RTC Alarm Resume (Disabled)**

When set to Enabled, you can set the date (day of the month), hour, minute and second to turn on your system. When set to 0 (zero) for the day of the month, the alarm will power on your system every day at the specified time.

---

- **Date of Month:** Use this field to define the date of month when using the RTC alarm to resume the system.
- **Resume Time:** Use this field to define the time when using the RTC alarm to resume the system.

## PNP/PCI Configurations

This section configures how PnP (Plug and Play) and PCI expansion cards operate in your system. The PCI bus on the motherboard use system IRQs (Interrupt ReQuests) and DMAs (Direct Memory Access). You must set up the IRQ and DMA assignments correctly through the PnP/PCI Configurations Setup utility for the motherboard to work properly. This screen appears after entering:

Phoenix-AwardBIOS CMOS Setup Utility  
PnP/PCI Configurations

Reset Configuration Data	[Disabled]	Item Help
Resources Controlled By * IRQ Resources	[Auto(ESCD)] Press Enter	Menu Level ► Default is Disabled. Select Enabled to reset Extended System Configuration Data
PCI/VGA Palette Snoop	[Disabled]	Setup if you have installed a new add-on and the system reconfiguration has caused such a serious conflict that the OS cannot boot
Assign IRQ For VGA	[Enabled]	
Assign IRQ For USB	[Enabled]	
PCI Latency Timer (CLK)	[ 64]	
** PCI Express relative items **		
Maximum Payload Size	[4096]	

↑↓→←: Move    Enter: Select    +/-/PU/PD: Value    F10: Save    ESC: Exit    F1: General Help  
F5: Previous Values    F6: Fail-Safe Defaults    F7: Optimized Defaults

### Reset Configuration Data (Disabled)

If you enable this option and restart the system, any Plug and Play configuration data stored in the BIOS Setup is cleared from memory.

### Resources Controlled By (Auto(ESCD))

You should leave this option at the default (Auto (ESCD)). Enabling this setting, the system dynamically allocates resources to Plug and Play devices as they are required. If you cannot get a legacy ISA (Industry Standard Architecture) expansion card to work properly, you might be able to solve the problem by changing this item to Manual, and then opening up the IRQ Resources submenu.

\* **IRQ Resources:**

In the IRQ Resources submenu, if you assign an IRQ to Legacy, then that Interrupt Request Line is reserved for a legacy ISA expansion card. In the Memory Resources submenu, use the first item Reserved memory Base to set the start address of the memory you want to reserve for the ISA expansion card. Use the second item Reserved Memory Length to set the amount of reserved memory. Press <Esc> to close the Memory Resources submenu.

**PCI/VGA Palette Snoop [Disabled]**

This option is designed to overcome problems that can be caused by some nonstandard VGA cards.

**Assign IRQ For VGA [Enabled]**

This option assigns an interrupt request (IRQ) to the VGA on your system. Activity of the selected IRQ always awakens the system.

**Assign IRQ For USB [Enabled]**

This option assigns an interrupt request (IRQ) to the USB on your system. Activity of the selected IRQ always awakens the system.

**PC Health Status**

Your mainboard supports hardware monitoring; this section lets you monitor the parameters for critical voltages, temperatures and fan speeds.

Phoenix-AwardBIOS CMOS Setup Utility  
PC Health Status

Shutdown Temperature	[Disabled]	Item Help
+1.8V Voltage	1.80v	Menu Level ►►
CPU Voltage	1.40v	
+3.3V Voltage	3.37v	
+5V Voltage	4.91v	
+12V Voltage	12.09v	
DIMM Voltage	2.64v	
NB Voltage	1.23v	
Voltage Battery	3.18v	
CPU Temperature	35C	
CPU FAN Spd	3924 RPM	
SYS FAN Spd	0 RPM	

↑↓→←: Move    Enter: Select    +/-/PU/PD: Value    F10: Save    ESC: Exit    F1: General Help  
F5: Previous Values    F6: Fail-Safe Defaults    F7: Optimized Defaults

**Shutdown Temperature [Disabled]**

Enables you to set the maximum temperature the system can reach before powering down.

### System Component Characteristics

These fields provide you with information about the systems current operating status. You cannot make changes to these fields.

- +1.8V Voltage
- CPU Voltage
- +3.3V Voltage
- +5V Voltage
- +12V Voltage
- DIMM Voltage
- NB Voltage
- Voltage Battery
- CPU Temperature
- CPU FAN Spd
- SYS FAN Spd

### Load Fail-Safe Defaults

If you select this item and press Enter a dialog box will appear. If you select [OK], and then Enter, the Setup Utility loads a set of performance default values. These default settings are quite demanding and your system might not function properly if you are using slower CPU, memory, or other low-performance components.

**Note:** To load Performance settings may make your system become unstable or unbootable. When loading the Performance Defaults fails, users can choose “either” step to return the motherboard to its defaults BIOS:

1. Power on the system and press “Insert” key. The system will bypass the previous BIOS setting and automatically reload the default BIOS. (This procedure is BIOS setup only!)
2. Apply to the jumper setting reference onboard and proceed with the “Clear CMOS” to recover the default BIOS setting. Please refer to Chapter 2, page 18, to complete the clear CMOS action. (This procedure requires opening the chassis!)

### Load Optimized Defaults

This option opens a dialog box that lets you install optimized defaults for all appropriate items in the Setup Utility. Press <Y> and then <Enter> to install the defaults. Press <N> and then <Enter> to not install the defaults. The optimized defaults place demands on the system that may be greater than the performance level of the components, such as the CPU and the memory. You can cause fatal errors or instability if you install the optimized defaults when your hardware does not support them. If you only want to install setup defaults for a specific option, select and display that option, and then press <F7>.

**Note:** Users please remain the factory BIOS default setting of “Load optimized Defaults” when install Operation System onto your system.

## Set Supervisor/User Password

When this function is selected, the following message appears at the center of the screen to assist you in creating a password.

### ENTER PASSWORD

Type the password, up to eight characters, and press <Enter>. The password typed now will clear any previously entered password from CMOS memory. You will be asked to confirm the password. Type the password again and press <Enter>. You may also press <Esc> to abort the selection. To disable password, just press <Enter> when you are prompted to enter password. A message will confirm the password being disabled. Once the password is disabled, the system will boot and you can enter BIOS Setup freely.

### PASSWORD DISABLED

If you have selected “**System**” in “Security Option” of “BIOS Features Setup” menu, you will be prompted for the password every time the system reboots or any time you try to enter BIOS Setup. If you have selected “**Setup**” at “Security Option” from “BIOS Features Setup” menu, you will be prompted for the password only when you enter BIOS Setup.

Supervisor Password has higher priority than User Password. You can use Supervisor Password when booting the system or entering BIOS Setup to modify all settings. Also you can use User Password when booting the system or entering BIOS Setup but can not modify any setting if Supervisor Password is enabled.

## Save & Exit Setup

Navigate to this option and press <Enter> to save the changes that you have made in the Setup Utility and exit the Setup Utility. When the Save and Exit dialog box appears, press <Y> to save and exit, or press <N> to return to the main menu.

## Exit Without Saving

Navigate to this option and press <Enter> to discard any changes that you have made in the Setup Utility and exit the Setup Utility. When the Exit Without Saving dialog box appears, press <Y> to discard changes and exit, or press <N> to return to the main menu.

**Note:** If you have made settings that you do not want to save, use the “Exit Without Saving” item and press <Y> to discard any changes you have made.

---

## Realtek HD Audio Driver Setup

### Getting Started

After Realtek HD Audio Driver being installed (insert the driverCD and follow the on-screen instructions), “Realtek HD Audio Manager” icon will show in System tray as below. Double click the icon and the control panel will appear:



Double click to enable  
Realtek HD Audio Manager

### Sound Effect

After clicking on the “Sound Effect” tab, 3 sections “Environment”, “Equalizer” and “Karaoke” are available for selection.



### Environment Simulation

You will be able to enjoy different sound experience by pulling down the arrow, totally 23 kinds of sound effect will be shown for selection. Realtek HD Audio Sound Manager also provides five popular settings “Stone Corridor”, “Bathroom”, “Sewer pipe”, “Arena” and “Audio Corridor” for quick enjoyment.

## Equalizer Selection

The Equalizer section allows you to create your own preferred settings by utilizing this tool.

In standard 10 bands of equalizer, ranging from 100Hz to 16KHz are available:

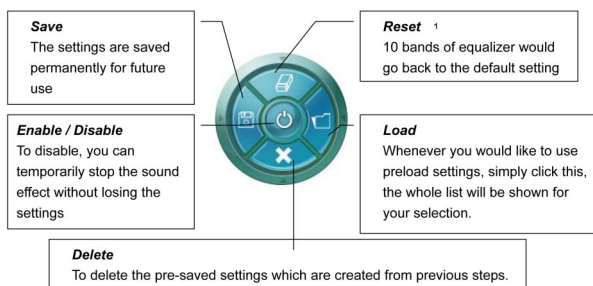
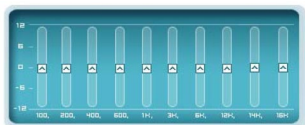

## Frequently Used Equalizer Setting

Realtek recognizes the needs that you might have. By leveraging our long experience at audio field, Realtek HD Audio Sound Manager provides you certain optimized equalizer settings that are frequently used for your quick enjoyment.

### How to Use

Other than the buttons “Pop” “Live” “Club” & “Rock” shown on the page, to pull down the arrow in “Others” , you will find more optimized settings available to you.

### Karaoke Mode

Karaoke mode brings Karaoke fun back home by simply using the music you usually play, Karaoke mode can help you eliminate the vocal of the song or adjust the key to accommodate your range.

**Vocal Cancellation:** Single click on “Voice Cancellation”, the vocals of the songs will be erased, while the background music is still playing which lets you take over the vocal part.

**Key Adjustment:** Using “Up / Down Arrow” to find a key which better fits your vocal range.

## Mixer

Realtek HD Audio Sound Manager integrates Microsoft's "Volume Control" functions into the Mixer page. This gives you the advantage to you to create your favorite sound effect in one single tool.



## Playback control

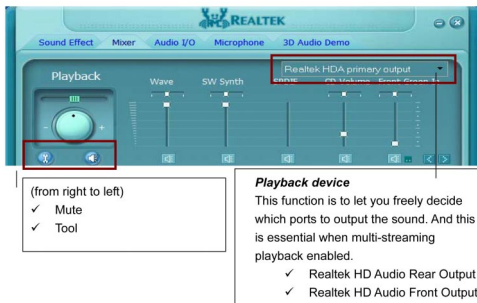

## Mute

You may choose to mute single or multiple volume controls or to completely mute sound output.

## Tool

### 3 Show the following volume control

This is to let you freely decide which volume control items to be displayed, total 13 items to be chosen.

### 3 Advanced controls

### 3 Enable playback multi-streaming



With this function, you will be able to have an audio chat with your friends via headphone (stream 1 from front panel) while still have music (stream 2 from back panel) playing. At any given period, you can have maximum 2 streams operating simultaneously.

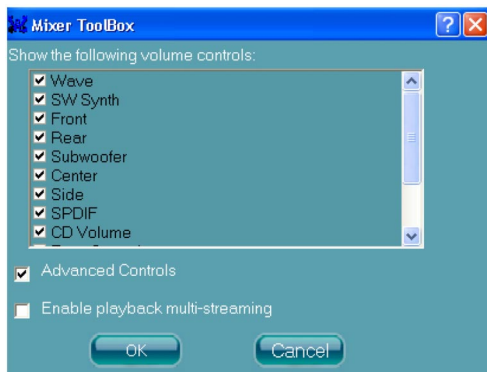

## Recording control

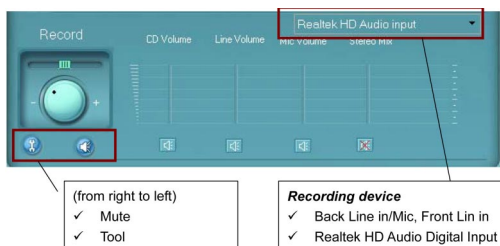

### Mute

You may choose to mute single or multiple volume controls or to completely mute sound input.

### Tool

#### 3 Show the following volume controls

This is to let you freely decide which volume control items to be displayed.

#### 3 Advanced controls.

Advanced control is a “Microphone Boost” icon.

Once this item is checked, you will find “advanced” icon beside “Front Pink In” & “Mic Volume”. With this, the input signal into “Front Pink In” & “Mic Volume” will be strengthened.

#### 3 Enable recording multi-streaming

At any given period, you can have maximum 2 streams operating simultaneously.



## Audio I/O

Realtek HD Audio Manager frees you from default speaker settings. Different from before, for each jack, they are not limited to perform certain functions. Instead, now each jack is able to be chosen to perform either output (i.e. playback) function or input (i.e. Recording) function, we call this "Retasking".

Audio I/O aims to help you setting jacks as you wish. Moreover, other than blue to blue, pink to pink, the way that you used to do, Audio I/O would guide you to other right jacks that can also serve as microphone / speaker / headphone.



## Speaker Configuration

**Step 1:** Plug in the device in any available jack.

**Step 2:** Dialogue “connected device” will pop up for your selection. Please select the device you are trying to plug in.

\* If the device is being plugged into the correct jack, you will be able to find the icon beside the jack changed to the one that is same as your device.

\* If not correct, Realtek HD Audio Manager will guide you to plug the device into the correct jack.

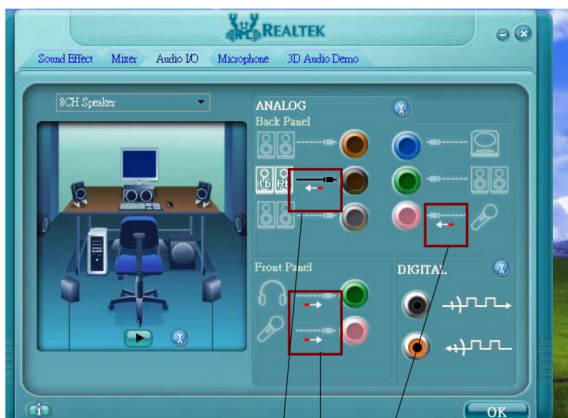
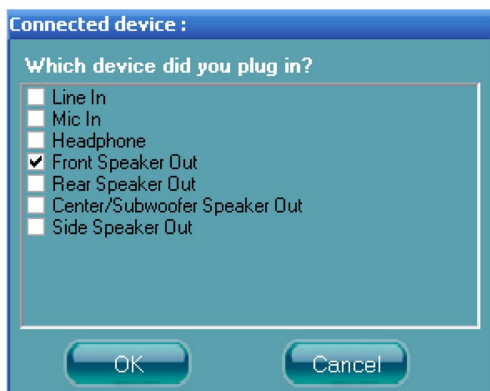

Indicates **pull-out**

(Find the arrow is at opposite direction to the jack?)

Indicates **plug in**

(Find the arrow is exactly into the jack?)

**Warning**  
This device type is not supported!

The warning message to hint you the device was plugged into a wrong jack.

## Global Connector Settings

Click  to access global connector settings

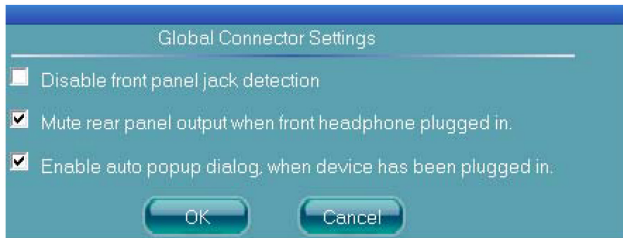

### 3 Mute rear panel when front headphone plugged in

Once this option is checked, whenever front headphone is plugged, the music that is playing from the back panel, will be stopped.

### 3 Disable front panel jack detection (option)

Did not find any function on front panel jacks?

Please check if front jacks on your system are so-called AC'97 jacks. If so, please check this item to disable front panel jack detection.

### 3 Enable auto popup dialogue, when device has been plugged in.

Once this item checked, the dialog "Connected device", would not automatically pop up when device plugged in.

## S/PDIF

Short for *Sony/Philips Digital Interface*, a standard audio file transfer format. S/PDIF allows the transfer of digital audio signals from one device to another without having to be converted first to an analog format. Maintaining the viability of a digital signal prevents the quality of the signal from degrading when it is converted to analog.



### 3 Output Sampling Rate

- 44.1KHz: This is recommend while playing CD
- 48KHz: This is recommended while playing DVD or Dolby.
- 96KHz: This is recommended while playing DVD-Audio.

### 3 Output Source

- Output digital audio source: The digital audio format (such as .wav, .mp3,.midi etc) will come out through S/PDIF-Out.
- S/PDIF-in to S/PDIF -out pass though mode: The data from S/PDIF-In can be real-time played from S/PDIF-Out.

## S/PDIF In Status

### Lock:

This is to express if the S/PDIF In data has been successfully caught by codec Sampling Rate

### Data Validation:

This indicates if the input data is known to Realtek HD Audio Manager.

### Copyright protection:

The input data can only be copied while “Copy Free” is shown; while “No Copy” indicates the data is read only.

### Real time S/PDIF-in monitor:

Not only S/PDIF out, but also other analog out (such as front /side/surround speakers) can also output S/PDIF-in data real-time.

## Speaker Calibration

After you have successfully plugged in speakers and assigned to the right jacks, you are only one more step to go to enjoy the intended sound. We provide “Speaker Calibration” to help you check if the speakers are located in the correct position.

**Step1**  
Select the channel output (headphone / 2 / 4/ 6 / 8 channel)

**Step2**  
Click “play” icon

**Step3**  
Look at the scene; while the speaker appears flushing, you should be able to hear the sound exactly from that direction.

## Microphone

This page is designed to provide you better microphone / recording quality.

Below picture indicates both “Noise Suppression” & “Acoustic Echo Cancellation” are both enabled.

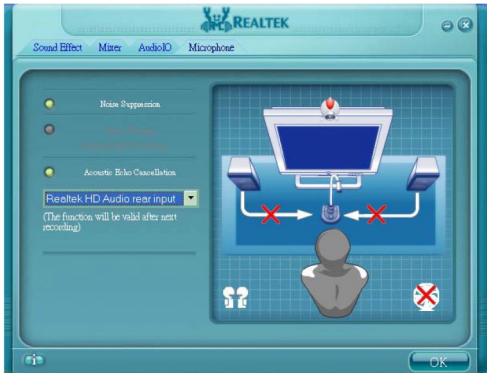

### Noise Suppression

If you feel that the background noise, especially the sound generated from the fan inside PC, is too loud? Try “Noise Suppression”, which allows you to cut off and suppress disturbing noise.

### Beam Forming

Also known as “directional recording”, this option lets you do the following: Once beam forming is enabled; only the sound from certain direction will be recorded. You will get the best quality if you chose 90° position, which we recommend you to use, this effectively means that you speak right into the microphone.

**Note:** A Stereo Microphone is required when using Beam Forming function.

### Acoustic Echo Cancellation

This function prevents playback sound from being recorded by microphone together with your sound. For example, you might have chance to use VOIP function through Internet with your friends. The voice of your friend will come out from speakers (playback). However, the voice of your friend might also be recorded into your microphone then go back to your friend through Internet. In that case, your friend will hear his/her own voice again. With AEC(Acoustic Echo Cancellation) enabled at your side, your friend can enjoy the benefit with less echo.

## Audio Demo

The section “3D Audio Demo” grants you another possibility to enjoy your sound. The Audio Demo allows you to listen to sound in an extraordinary way.



## Information

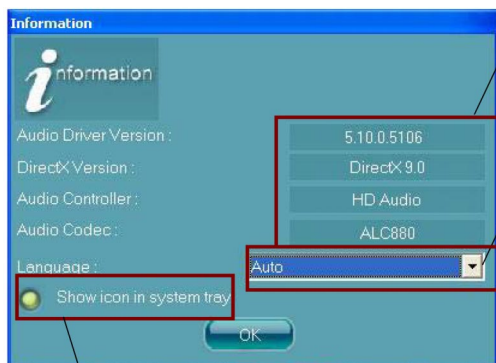

Hardware / Software information of your audio system

**Language setting**  
When “Auto” is chosen, this language setting would accommodate to OS language on your systems

Quick launch button at System tray

This section provides information about your current system audio device.

## BIOS Update Procedure

The program AWDFLASH.EXE is included on the driver CD (D:\Utility\AWDFLASH.EXE). It is recommended to follow the procedure below to update the BIOS.

1. Create a DOS-bootable floppy diskette. Copy the new BIOS file (just obtained or downloaded) and the utility program AWDFLASH.EXE to the diskette.
2. Allow the PC system to boot from the DOS diskette.
3. At the DOS prompt, type

**AWDFLASH<ENTER>**

4. Enter the file name of the new BIOS.
5. The question: "Do you want to save BIOS (Y/N)?" is displayed.

***Press "N" if there is no need to save the existing BIOS.  
Press "Y" if a backup copy of the existing BIOS is needed.  
(A file name has to be assigned to the existing BIOS binary file.)***

6. The message : "Press "Y" to program or "N" to exit" is displayed. Type

**"Y"<ENTER>**

7. Wait until the flash-update is completed.
8. Restart the PC.

<p><b>Warning :</b> - Do not turn off or RESET the computer during the flash process. - If you are not sure how to upgrade the BIOS, please take your computer to an Authorized Service Center and have a trained technician do the work for you.</p>
---

### Note to User:

The bundled driver CD includes an automatic software feature for all drivers that the motherboard need. Please select the drivers that you want to install and click the button on the installation panel.