



Electronic Emission Notices

Federal Communications Commission (FCC) Statement

This equipment has been tested and found to comply with the limits for a Class B digital device, pursuant to Part 15 of FCC Rules. These limits are designed to provide reasonable protection against harmful interference in a residential installation. This equipment generates, uses and can radiate radio frequency energy and, if not installed and used in accordance with instructions contained in this manual, may cause harmful interference to radio and television communications. However, there is no guarantee that interference will not occur in a particular installation.

If this equipment does cause harmful interference to radio or television reception, which can be determined by turning the equipment off and on, the user is encouraged to try to correct the interference by one or more of the following measures:

- REORIENT OR RELOCATE THE RECEIVING ANTENNA
- INCREASE THE SEPARATION BETWEEN THE EQUIPMENT AND THE RECEIVER
- CONNECT THE EQUIPMENT INTO AN OUTLET ON A CIRCUIT DIFFERENT FROM THAT OF THE RECEIVER
- CONSULT THE DEALER OR AN EXPERIENCED AUDIO/TELEVISION TECHNICIAN

NOTE: Connecting this device to peripheral devices that do not comply with Class B requirements, or using an unshielded peripheral data cable, could also result in harmful interference to radio or television reception.

The user is cautioned that any changes or modifications not expressly approved by the party responsible for compliance could void the user's authority to operate this equipment.

To ensure that the use of this product does not contribute to interference, it is necessary to use shielded I/O cables.

Copyright

This manual is copyrighted with all rights reserved. No portion of this manual may be copied or reproduced by any means.

While every precaution has been taken in the preparation of this manual, no responsibility for errors or omissions is assumed. Neither is any liability assumed for damages resulting from the use of the information contained herein.

Trademarks

All brand names, logos and registered trademarks mentioned are property of their respective owners.

Table of Contents

HARDWARE CONFIGURATION	3
Key Features	3
Motherboard Layout	5
Jumper Settings	6
CPU Speed Selection	6
JU1, JU2 - CPU Clock Speed	6
JU3 - LAN Setting (optional)	6
JU13 - CMOS Clear	6
Pin Assignment	7
HARDWARE SETUP	8
To Install DDR DIMMs	8
Installing a New Processor	9
To Install a Processor to ZIF Socket	9
Connect the Processor Fan Connector	9
Setting the Processor Speed	9
BIOS SETUP	10
Starting Setup	10
Main Menu	11
Standard CMOS Features	12
Advanced BIOS Features	13
Advanced Chipset Features	14
Integrated Peripherals	15
Power Management Setup	16
PnP/PCI Configurations	17
Set Password	18
Flash Update Procedure	19
APPENDIX	20
Select the Heatsink	20
Select the Power Supply	20

HARDWARE CONFIGURATION

Key Features :

Chipset

- ATI A3 + ALI M1535D+ Chipset.

Processor

- Full supports AMD Athlon™ XP, Athlon™ and Duron™ processors use Socket A.
- Supports bus speed of 100/133MHz processors.

VRM 9.0 (Voltage Regulator Modules) on Board

- Flexible motherboard design with on board VRM 9.0.

System Memory

- A total of two 184pin DDR SDRAM sockets.
- Supports 4 banks up to 1GB DRAMs (512Mb x8/x16 DRAM technology).
- Supports DDR SDRAM memory types.
- Mixed 1M / 2M / 4M / 8M / 16M / 32M / 64M x N DRAMs.
- 2.5V DRAM interface for DDR SDRAM.
- 8 MB to 256 MB of main memory configurable as display memory.
 - Max. 64MB display memory is selectable if there is 128MB main memory.
 - Max. 128MB display memory is selectable if there is 256MB main memory.
 - Max. 256MB display memory is selectable if there is 512MB or above main memory.

System BIOS

- PnP, APM, ATAPI and Windows® 98/2000/XP.
- Full support of ACPI & DMI.
- Auto detects and supports LBA harddisk with capacities over 8.4GB.
- Easy to upgrade BIOS by end user.

On-board I/O

- On board two PCI fast IDE ports supporting up to 4 ATA, ATA2 and Ultra DMA33/66/100 IDE devices.
- One ECP/EPP parallel port.
- Two 16550 Compatible UART serial ports.
- One floppy port supports two FDD of 360KB, 720KB, 1.2MB , 1.44MB and 2.88MB capacity.
- Six USB ports (four ports via two headers, USB2 Connector only supports USB1.1, other ports support USB2.0).
- PS/2 mouse is supported.
- PS/2 keyboard is supported.
- One Line/speaker out, one Mic in, one line in and MIDI/Gameport.
- One TV-out connector.
- Infrared (IrDA) is supported via a header.

Plug-and-Play

- Supports Plug and Play specification 1.1.
- Plug and Play for Windows® 98/2000 as well as Windows® XP.
- Fully steerable PCI interrupts.

On Board VGA

- Integrated ATI Radeon 7000 graphic core.
- Supports Dual display (one CRT, one TV out).
- Integrated DAC and CRT controllers.
- Full screen/Full speed video playback.
- Up to 1600x1200, non-interlaced screen resolution for CRT.

TV Out

- Integrated TV encoder.
- 10-bit DAC with 4-tap filter.
- PAL/NTSC TV Out with Composite and S-Video Outputs.
- ATI's exclusive "Composite Dot Crawl" freeze option for PAL and NTSC to improve the picture quality.
- TV-Out power management support.

Full Featured Accelerated Graphics Port (AGP)

- AGP v2.0 compliant.

Power Management

- Supports SMM, APM and ACPI.
- Break switch for instant suspend/resume on system operations.
- Energy star "Green PC" compliant.
- WOL (Wake-On-Lan) header support.
- External Modem Ring-in Wake-up support.
- Supports suspend-to-RAM(STR)(optional).

On-board AC97 Sound (optional)

- Integrated AC97 controller with standard AC97 Codec.
- Direct Sound and Sound Blaster compatible.
- Full-Duplex 16-bit record and play back.
- PnP and APM 1.2 support.
- Windows® 98/2000/XP drivers ready.
- Line-in, Line-out, Mic-in and MIDI/Game port.

On-board Realtek RTL8100BL PCI LAN (optional)

- Provides 32-bit performance, PCI bus master capability.
- Full compliance with IEEE 802.3u 100 Base-T specifications and IEEE 802.3X Full Duplex Flow Control.
- Supports 10 Mb/s and 100 Mb/s operation.
- Supports Wake-On-LAN function and remote wake-up.
- Supports ACPI, PCI Power management and PCI VPD.

Expansion Slots

- 1 AGP slot (AGP 2.0 compliant).
- 3 PCI bus master slots - ver. 2.1 compliant.

CAUTION

Static electricity can harm delicate components of the motherboard. To prevent damage caused by static electricity, discharge the static electricity from your body before you touch any of the computers electronic components.

Motherboard Layout (35-A275-X1-XX)

The following diagrams show the relative positions of the jumpers, connectors, major components and memory banks on the motherboard.

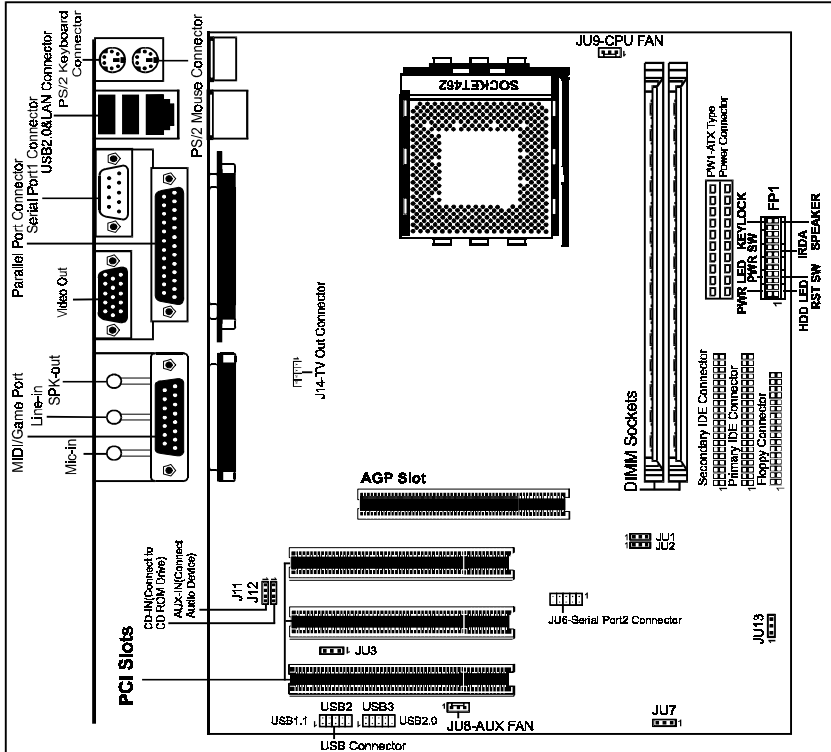

The LAN Connector is optional.

USB2 Connector only supports USB1.1, other ports support USB2.0.

NOTE

- 1) Be sure to check the cable orientation in order to match the colored strip to the pin 1 end of the connector.
- 2) When you start up the system, please wait for 5 seconds after you power on AC.
- 3) Only 4X AGP Card (1.5V) can be inserted in this motherboard, otherwise it may be harmful to your motherboard.

Jumper Settings

This chapter explains how to configure the motherboard's hardware. Before using your computer, make sure all jumpers and DRAM modules are set correctly. Refer to this chapter whenever in doubt.

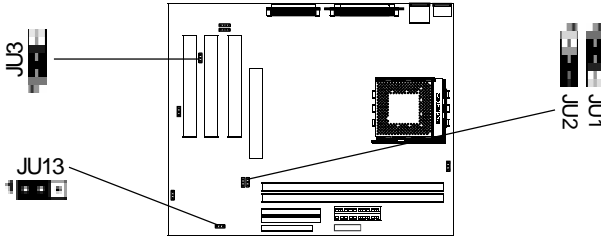

CPU Speed Selection

In this motherboard, no jumper is required to be set for different type of CPU installed.

JU1, JU2 - CPU Clock Speed

JU1	JU2	CPU Clock Speed
1-2*	2-3*	100MHz*
2-3	1-2	133MHz

JU3 - LAN Setting (optional)

JU3	Function
1-2*	Enable Lan*
2-3	Disable Lan

JU13 - CMOS Clear

JU13	Selection
1-2*	Normal*
2-3	CMOS Clear



Close



Open

* = Default setting.

Pin Assignment

Internal Audio Connector

J11 : AUX-IN



Pin	Assignment
1	AUX-L
2	GND
3	GND
4	AUX-R

J12 : CD-IN



Pin	Assignment
1	CD-L
2	GND
3	GND
4	CD-R

USB Connector



Pin	Assignment
1	VCC
2	VCC
3	USBP0-
4	USBP1-
5	USBP0+
6	USBP1+
7	GND
8	GND
9	KEY
10	OC#

J14 TV Out Connector

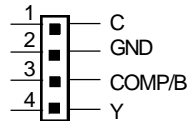

FP1 FRONT PANEL HEADER HEADER 2x12

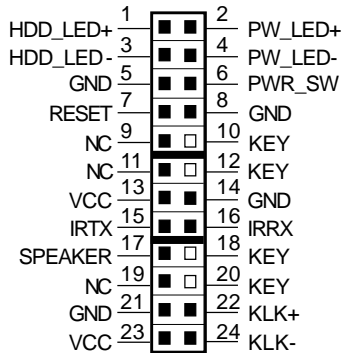

Hardware Setup

To Install DDR DIMMs

1. Locate the DDR DIMM sockets.
2. Holding the DDR DIMM by the edges, remove it from its antistatic package.
3. Make sure the clips at either end of the socket are pushed away from the socket.

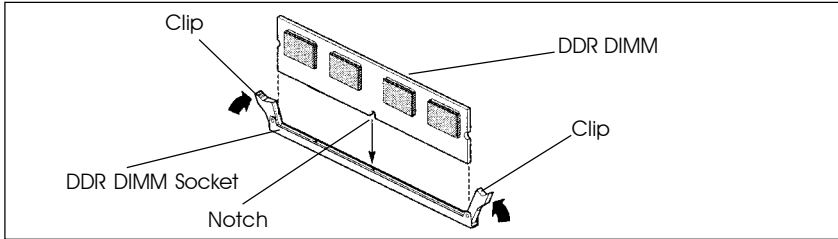

4. Position the DDR DIMM above the socket. Align the notch in the bottom edge of the DDR DIMM with the keys in the socket.
5. Insert the bottom edge of the DDR DIMM into the socket.
6. When the DDR DIMM is seated, push down on the top edge of the DDR DIMM until the retaining clips at the ends of the socket snap into place. Make sure the clips are firmly in place.



Please turn off system before installing and removing any device, otherwise you'll cause the system damage.

Installing a New Processor

An upgrade processor can dramatically increase general system speed and performance.

Most microprocessor upgrade kits include the following items:

- Microprocessor chip
- Installation instructions and technical data

Your system may have these features built in, or support them as upgrades.

To Install a Processor to ZIF Socket

To install the processor, follow these steps:

1. If the system microprocessor is already on the motherboard socket, you need to remove it from the motherboard socket. The socket is a Zero Insertion Force (ZIF) socket which has a metal arm at one side. Carefully grasp this arm, move it horizontally away from the socket and lift it up. Eventually you will be able to lift the chip straight up out of the socket. Be careful not to bend any pins.

Be careful not to bend any of the pins when removing the microprocessor chip from its socket. The microprocessor chip can be permanently damaged.

2. Unpack the new microprocessor chip.
3. Carefully align the processor with the correct orientation to the socket on the motherboard.
4. Carefully insert the processor into the socket, and move the metal arm downward to replace it in its original position.

Connect the Processor Fan Connector

There is a fan attached the processor to prevent the overheating. Connect the processor fan cable to the fan connector that located on the motherboard near the processor and ensure the fan can operate. Otherwise the CPU can overheat and cause ***damage to both CPU and motherboard.***

Setting the Processor Speed

After you install the processor into the motherboard, set the processor speed by CMOS setup.

BIOS Setup

This chapter discusses Award's Setup Program built into the ROM BIOS. The Setup Program allows users to modify the basic system configuration. This special information is then stored in battery-backed RAM, which retains the setup information when the power is turned off.

Starting Setup

The Award BIOS is immediately activated when you turn on the computer. The BIOS reads the system information contained in the CMOS and begins the process of checking out the system and configuring it. When it finishes, the BIOS will seek an operating system on one of the disks and then launch and turn control over to the operating system.

While the BIOS is in control, the Setup Program can be activated :

1. By pressing immediately after switching the system on, or
2. By pressing the key when the following message appears briefly at the bottom of the screen during the POST (Power On Self Test)

Press DEL to enter SETUP

If the message disappears before you can respond and you still wish to enter Setup, restart the system to try again by turning it OFF then ON or pressing the "RESET" button on the system case. You may also restart by simultaneously pressing the <Ctrl>, <Alt>, and <Delete> keys. If you do not press the keys at the correct time and the system does not reset, an error message will be displayed and you will again be asked to ...

PRESS F1 TO CONTINUE, DEL TO ENTER SETUP

Getting Help

Press F1 to pop up a small help window that describes the appropriate keys to use and the possible selections for the highlighted item. To exit the Help Window press <Esc> or the F1 key again.

In Case of Problems

If, after making and saving system changes with the Setup Program, you discover that your computer does not reset, use the Award BIOS defaults to override the CMOS settings.

Main Menu

Once you enter the Award BIOS CMOS Setup Utility, the Main Menu will appear on the screen. The Main Menu allows you to select from various setup functions and two exit choices. Use the arrow keys to select among the items and press <Enter> to accept and enter the sub-menu.

Phoenix - AwardBIOS CMOS Setup Utility	
<ul style="list-style-type: none"> ▶ Standard CMOS Features ▶ Advanced BIOS Features ▶ Advanced Chipset Features ▶ Integrated Peripherals ▶ Power Management Setup ▶ PnP/PCI Configurations 	<ul style="list-style-type: none"> Load Fail-Safe Defaults Load Optimized Defaults Set Password Save & Exit Setup Exit Without Saving
Esc : Quit F10 : Save & Exit Setup	↑↓→← : Select Item
Time, Date, Hard Disk Type	

(Note : The figures of BIOS Setup Menu included here only show a typical case, and may not be exactly the same as the one on your unit.)

Note that a brief description of each highlighted item will appear at the bottom of the screen.

Standard CMOS Features This setup page includes all the items of Award™ special standard features.

Advanced BIOS Features This setup page includes all the items of Award™ special enhanced features.

Advanced Chipset Features This setup page includes all the items of chipset special features.

Integrated Peripherals This section page includes all the items of IDE hard drive and Programmed Input / Output features.

Power Management Setup This entry only appears if your system supports Power Management "Green PC" standards.

PnP/PCI Configurations This entry appears if your system supports PNP/PCI.

Load Fail-Safe Defaults The BIOS defaults have been set by the manufacturer and represent settings which provide the minimum requirements for your system to operate.

Load Optimized Defaults The chipset defaults are settings which provide for maximum system performance. While Award has designed the custom BIOS to maximize performance, the manufacturer has the right to change these defaults to meet its needs.

Set Password Changes, sets, or disables password. It allows you to limit access to the system and the Setup Program.

Save & Exit Setup Saves value changes to CMOS and exits setup.

Exit Without Saving Abandons all CMOS value changes and exits setup.

Standard CMOS Features

The items in Standard CMOS Setup Menu are divided into 10 categories. Each category includes one or more setup items. Use the arrow keys to highlight the item and then use the <PgUp> or <PgDn> key to select the desired value in each item.

Phoenix - AwardBIOS CMOS Setup Utility
Standard CMOS Features

Date (mm :d d :yy)	Wed, Jan 01 2003	Item Help
Time (h h :mm:ss)	11 : 1 : 35	
▶ IDE Primary Master	[None]	Menu Level ▶
▶ IDE Primary Slave	[None]	Change the day, month, year and century
▶ IDE Secondary Master	[None]	
▶ IDE Secondary Slave	[None]	
Drive A	[1.44M, 3.5 in.]	
Drive B	[None]	
Video	[EGA/VGA]	
Halt on	[All, But Keyboard]	
Base Memory	640K	
Extended Memory	64512K	
Total Memory	65536K	

↑↓→← : Move Enter : Select +/-/PU/PD : Value F10 : Save ESC : Exit F1 : General Help
F5 : Previous Values F6 : Fail-Safe Defaults F7 : Optimized Defaults

(Note : The figures of BIOS Setup Menu included here only show a typical case, and may not be exactly the same as the one on your unit.)

Date	The date format is <day-of-the-week>. <month> <day> <year>.
Time	The time format is <hour> <Minute> <second> displayed in 24-hour military-time clock. For example, 1 p. m. is displayed as 13:00:00.
IDE Primary Master/Slave	These categories identify the types of the two channels that have been installed in the computer.
IDE Secondary Master/Slave	
Drive A / Drive B	This category identifies the types of floppy disk drive A or drive B that has been installed in the computer.
Video	The default setting is EGA/VGA.
Halt on	You can select which type of error will cause the system to halt.

Advanced BIOS Features

This section allows you to configure your system for basic operation. You have the opportunity to select the boot-up sequence, keyboard operation, shadowing and security.

The following figure is the details of **Advanced BIOS Features**.

Phoenix - AwardBIOS CMOS Setup Utility
Advanced BIOS Features

		Item Help
Virus Warning	[Disabled]	Menu Level ▶ Allows you to choose the VIRUS warning feature for IDE Hard Disk boot sector protection. If this function is enabled and someone attempt to write data into this area, BIOS will show a warning message on screen and alarm beep
CPU Internal Cache	[Enabled]	
External Cache	[Enabled]	
Quick Power On Self Test	[Enabled]	
First Boot Device	[Floppy]	
Second Boot Device	[HDD-0]	
Third Boot Device	[LS120]	
Boot Other Device	[Enabled]	
Swap Floppy Drive	[Disabled]	
Boot Up Floppy Seek	[Enabled]	
Boot Up NumLock Status	[On]	
Boot Up System Speed	[High]	
Gate A20 Option	[Fast]	
Typematic Rate Setting	[Disabled]	
x Typematic Rate (Chars/Sec)	[6]	
x Typematic Delay (Msec)	[250]	
Security Option	[Setup]	
OS Select For DRAM > 64MB	[Non-OS2]	
Video BIOS Shadow	[Enabled]	

↑↓ : Move Enter : Select +/-PU/PD : Value F10 : Save ESC : Exit F1 : General Help
 F5 : Previous Values F6 : Fail-Safe Defaults F7 : Optimized Defaults

Advanced Chipset Features

This section allows you to configure DRAM clock, DRAM timing, AGP mode etc.

The following figure is the details of **Advanced Chipset Features**.

Phoenix - AwardBIOS CMOS Setup Utility
Advanced Chipset Features

		Item Help
Memory Frequency For	[SYNC]	Menu Level ▶
DRAM CAS Select	[SPD]	
AT Bus Clock	[CLK2/4]	
System BIOS Cacheable	[Disabled]	
AGP Aperture Size	[64MB]	
UMA Frame Buffer Size	[32MB]	
Video Display Devices	[Auto]	
Tv Standard	[NTSC]	
Memory Hole At 15M-16M	[Disabled]	
I/O Recovery Period	[1 us]	
ALI OnChip Audio	[Enabled]	
CPU Fan	[5333RPM]	
Passive Release	[Disabled]	



↑↓→← : Move Enter : Select +/-/PU/PD : Value F10 : Save ESC : Exit F1 : General Help
 F5 : Previous Values F6 : Fail-Safe Defaults F7 : Optimized Defaults

Integrated Peripherals

The Integrated Peripherals Setup allows the user to configure the onboard IO, IRQ, DMA assignment etc.

The following figure is the details of **Integrated Peripherals**.

Phoenix - AwardBIOS CMOS Setup Utility
Integrated Peripherals

On-Chip Primary IDE	[Enabled]		Item Help	
Master PIO	[Auto]			Menu Level ▶
Slave PIO	[Auto]			
Master Ultra DMA	[Auto]			
Slave Ultra DMA	[Auto]			
On-Chip Secondary IDE	[Enabled]			
Master PIO	[Auto]			
Slave PIO	[Auto]			
Master Ultra DMA	[Auto]			
Slave Ultra DMA	[Auto]			
On-Chip USB Controller	[Enabled]			
USB Keyboard Support	[Disabled]			
Init Display First	[PCI Slot]			
IDE HDD Block Mode	[Enabled]			
POWER ON Function				
KB Power ON Password	[Enter]			
Hot Key Power ON	[Ctrl-F1]			
Onboard FDC Controller	[Enabled]			
Onboard Serial Port 1	[Disabled]			

↑↓→← : Move Enter : Select +/-/PU/PD : Value F10 : Save ESC : Exit F1 : General Help
 F5 : Previous Values F6 : Fail-Safe Defaults F7 : Optimized Defaults

Power Management Setup

The Power Management Setup Menu allows you to configure your system to most save energy while operating in a manner consistent with your own style of computer use.

The following figure is the details of **Power Management Setup**.

Phoenix - AwardBIOS CMOS Setup Utility
Power Management Setup

ACPI Function	[Enabled]		Item Help
Power Management	[User Define]		
PM Control by APM	[No]		
MODEM Use IRQ	[3]		
Video Off In Suspend	[Yes]		
Video Off Method	[DPMS]		
PM Timers			
HDD Power Down	[Disabled]		
Suspend Mode	[Disabled]		
*** PowerOn\WakeUp Function ***			
Soft-Off by PWR-BTTN	[Instant-Off]		
SLEEP BUTTON	[Disabled]		
WakeOn PCI Card	[Disabled]		
WakeOn Lan	[Disabled]		
Resume by Alarm	[Disabled]		
x Date(of Month) Alarm	[0]		
			Menu Level ▶

↑↓→← : Move Enter : Select +/-/PU/PD : Value F10 : Save ESC : Exit F1 : General Help
 F5 : Previous Values F6 : Fail-Safe Defaults F7 : Optimized Defaults

PnP/PCI Configurations

This section describes how to configure the PCI bus system. This section covers some very technical items and it is recommended that only experienced users should make any changes to the default settings.

The following figure is the details of **PnP/PCI Configurations**.

Phoenix - AwardBIOS CMOS Setup Utility
PnP/PCI Configurations

Reset Configuration Data	[Disabled]	Item Help
Resources Controlled By	[Auto(ESCD)]	Menu Level ▶
x IRQ Resources	[Press Enter]	
x DMA Resources	[Press Enter]	
PCI/VGA Palette Snoop	[Disabled]	
Assign IRQ For VGA	[Enabled]	
PCI IRQ Activied By	[Level]	
		Default is Disabled. Select Enabled to reset Extended System Configuration Data ESCD) when you exit Setup if you have installed a new add-on and the system reconfiguration has caused such a serious conflict that the OS cannot boot

↑↓→← : Move Enter : Select +/-/PU/PD : Value F10 : Save ESC : Exit F1 : General Help
 F5 : Previous Values F6 : Fail-Safe Defaults F7 : Optimized Defaults

Set Password

When you select this function, the following message will appear at the center of the screen to assist you in creating a password.

ENTER PASSWORD:

Type the password, up to eight characters in length, and press<Enter>. The new password will clear the previously entered password from the CMOS memory. You will be asked to confirm the password. Type the password again and press <Enter>. You may also press <Esc> to abort the selection and operate without a password.

To disable a password, just press <Enter> when you are prompted to enter the password. A message will be displayed to confirm that the password is disabled.

PASSWORD DISABLED.

Once the password is disabled, the system will reset and you can enter the Setup Program freely.

When a password is enabled, you will be prompted to enter it every time you try to enter setup. This prevents an unauthorized person from changing any setting of your system configuration.

In addition, when a password is enabled, you can require the BIOS to request a password every time your system is rebooted. This would further prevent unauthorized use of your computer.

The password requirement is defined by the Security Option of the BIOS Features Setup Menu. If the Security Option is set to "System", the password will be required both at resetting and at entering setup. If the option is set to "Setup", the prompt only appears when you try to enter setup.

Flash Update Procedure

A program AWDFLASH.EXE is included in the utility diskette or CD (X:\Utility\AWDFLASH.EXE). The user is recommended to follow the procedure below to update the flash BIOS.

(X: your CD driver letter).

1. Create a DOS-bootable floppy diskette. Copy the new BIOS file (just obtained or downloaded) and the utility program AWDFLASH.EXE to the diskette.
2. Allow the PC system to boot from the DOS diskette.
3. At the DOS prompt, key in

AWDFLASH
and hit <ENTER>

4. Enter the file name of the new BIOS.
5. The question: "Do you want to save BIOS (Y/N)?" is displayed.

*Key in "N" if there is no need to save the existing BIOS content..
Key in "Y" if a backup copy of the existing BIOS is needed.
(A file name has to be assigned to the existing BIOS binary file.)*

6. The question : "Are you sure to program (Y/N)?" is displayed.

Key in "Y"

7. Wait until the flash-update is completed.
8. Power down the PC system.
9. Restart the PC.

Warning:

DO not turn off or RESET the computer during the flash process.

If you are unsure how to upgrade the BIOS, it is best to take your computer to an Authorized Service Center and have a trained technician do the work for you.

APPENDIX

Note to User:

The bundled driver CD attached an Auto-Run feature for all the drivers that the motherboard need. Please select the drivers that you want to install and click the button on the installation panel.

Select the Heatsink

Any attempt to operate the AMD Athlon™ Processor without a suitable cooling solution will result in permanent damage to the processor and potentially other components within the system.

You should pay attention when installing the heatsink and make sure that the heatsink is properly contacting with the CPU die surface. Moreover, besides the CPU die surface, the heatsink surface MUST NOT contact with any components on the CPU surface, otherwise the permanent CPU and motherboard damage will be resulted in.

This following collection of heatsinks are recommended for use with AMD Athlon™ processors. For the full list of heatsinks evaluated by AMD, please refer to the AMD web site.

- 1) Asian Vital Component (AVC) 112600
- 2) Coolermaster DP5-6H51-A1
- 3) Coolermaster DP5-6H11-A1
- 4) Coolermaster DP5-5G11-M4
- 5) Foxconn PK8001AED1652
- 6) Foxconn PK8921AED1652

Select the Power Supply

To ensure reliable operation of the motherboard based on AMD Athlon™ processor, a power supply to provide the power sequencing and current requirements of your systems is required, especially you run your systems at 1GHz or above 1GHz.

You can select a proper power supply via the web site of AMD:

<http://www1.amd.com/athlon/power>, or refer to the following list of power supplies that have been evaluated by us:

Manufacturer	Part Number (Model)	Wattage	Combined Power
Delta Electronics Inc.	DPS300 KB-1 REVS1	300	220V
Enhance Electronics	ENP-0735	350	220V
Golden Field	K7-335	300	220V
HEDY Computer Co.LTD	DPS200PB	300	220V