

A thick, horizontal blue brushstroke graphic that spans across the width of the page, positioned below the number '1' and above the main title.

# *Getting Started*

Thank you for choosing the MS-6577 v3.X Micro ATX mainboard. The MS-6577 is based on Intel® Brookdale-GE & ICH4 chipsets for optimal system efficiency. Designed to fit the advanced Intel® P4 Willamette and Northwood processors in 478-pin package, the MS-6577 delivers a high performance and professional desktop platform solution.

## Mainboard Specifications

### CPU

- Supports Socket 478 for Intel® P4 Willamette and Northwood processors.
- Supports 1.4GHz to 2.8GHz or higher speed.

### Chipset

- Intel® 845GE chipset
  - FSB 400/533MHz.
  - AGP 4x universal slot.
  - Integrated 3D/2D graphic core.
  - Supports DDR333/266/200 memory.
- Intel® ICH4 chipset
  - Hi-Speed USB (USB2.0) controller, 480Mb/sec.
  - 2 channel Ultra ATA 100 bus Master IDE controller.
  - PCI Master 2.2.
  - I/O APIC.
  - AC'97 2.2 interface.
  - 3 UHCI Host controllers and 1 EHCI Host controller.

### Main Memory

- Supports four memory banks using two 184-pin unbuffered DDR333/266/200 DIMM.
- Maximum memory size is 2GB without ECC (1GB/slot).
- Supports 2.5V DDR DIMM.

### Slots

- One AGP (Accelerated Graphics Port) 4x slot.
- Three 32-bit Master PCI (Peripheral Component Interconnect) Bus slots.

### Onboard IDE

- An IDE controller on the ICH4 chipset provides IDE HDD/CD-ROM with PIO, Bus Master and Ultra DMA100/66 operation modes.
- Can connect up to four IDE devices.

### Onboard Peripherals

- Onboard peripherals include:
  - 2 PS/2 Ports
  - 6 USB Ports (Rear x 4 /Front x 2)

- 1 Parallel Port + 1 Serial Port + 1 VGA Port
- 2 IEEE 1394 Ports (Rear x 1/Front x 1)
- 1 RJ-45 LAN Port
- Vertical Audio Ports (Line\_in, Line\_out, Mic\_in)
- IDE x 2 (ATA100), Floppy x 1, ATX power connector
- AUX\_IN x 1/MIC\_IN x 1
- Front panel pinheader x 1
- Clear password pinheader x 1
- Clear CMOS pinheader x 1

### **Audio**

- AC'97 link controller integrated in ICH4.
- Six-channel software codec RealTek ALC658 (Optional).

### **IEEE1394**

- VIA VT6307 IEEE 1394 chip integrated onboard.

### **LAN**

- RealTek RTL8101L chip
  - Integrated Fast Ethernet MAC and PHY in one chip.
  - Supports 10 Mb/s and 100 Mb/s.
  - Compliance with PCI v2.2.
  - Supports ACPI Power Management.

### **BIOS**

- PnP (Plug & Play) BIOS to detect peripheral devices and expansion cards automatically.
- DMI (Desktop Management Interface) function to record motherboard specifications.

### **Dimension**

- Micro-ATX Form Factor: 9.6" x 9.1"

### **Mounting**

- 6 mounting holes.

## Mainboard Layout

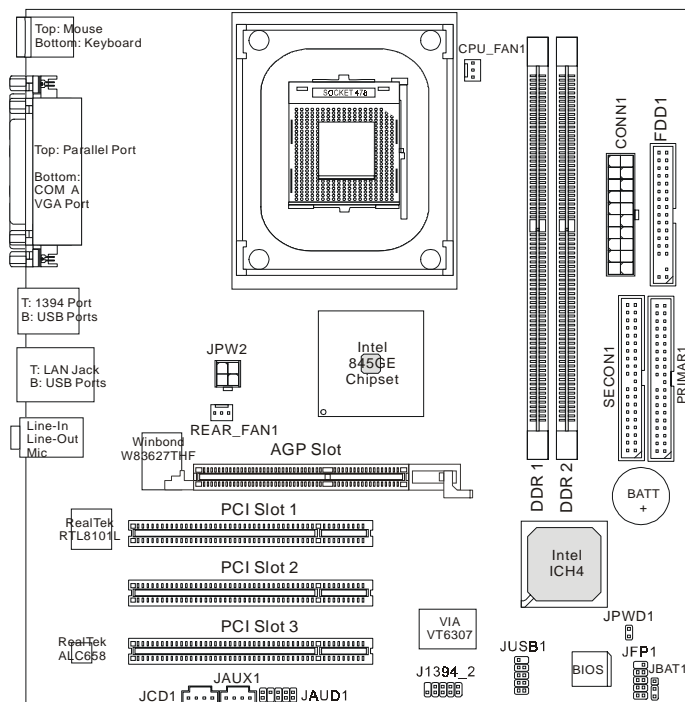

**MS-6577 v3.X Micro ATX Mainboard**



### MSI Reminds You...

*Enabling the functionality of Hyper-Threading Technology for your computer system requires ALL of the following platform Components:*

- \*CPU: An Intel® Pentium® 4 Processor with HT Technology;*
- \*Chipset: An Intel® Chipset that supports HT Technology;*
- \*BIOS: A BIOS that supports HT Technology and has it enabled;*
- and*
- \*OS: An operating system that supports HT Technology.*

*For more information on Hyper-threading Technology, go to:*

***<http://www.intel.com/info/hyperthreading>***

# 2

## *Hardware Setup*

This chapter provides you with the information about hardware setup procedures. While doing the installation, be careful in holding the components and follow the installation procedures. For some components, if you install in the wrong orientation, the components will not work properly.

Use a grounded wrist strap before handling computer components. Static electricity may damage the components.

# Quick Components Guide

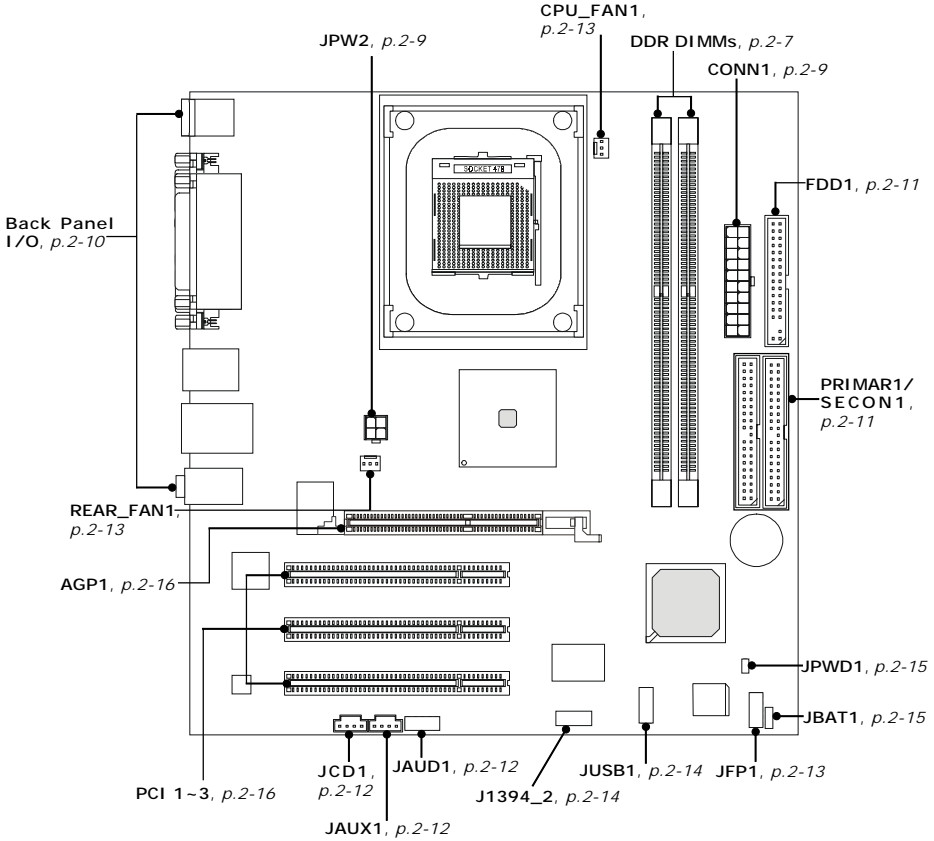

## Central Processing Unit: CPU

The mainboard supports Intel® Pentium® 4 processors in the 478 pin package. The mainboard uses a CPU socket called PGA478 for easy CPU installation. When you are installing the CPU, **make sure the CPU has a heat sink and a cooling fan attached on the top to prevent overheating.** If you do not find the heat sink and cooling fan, contact your dealer to purchase and install them before turning on the computer.

### CPU Core Speed Derivation Procedure

|             |                |   |                             |
|-------------|----------------|---|-----------------------------|
| <b>If</b>   | CPU Clock      | = | 100MHz                      |
|             | Core/Bus ratio | = | 14                          |
| <b>then</b> | CPU core speed | = | Host Clock x Core/Bus ratio |
|             |                | = | 100MHz x 14                 |
|             |                | = | 1.4 GHz                     |



#### MSI Reminds You...

##### ***Overheating***

*Overheating will seriously damage the CPU and system, always make sure the cooling fan can work properly to protect the CPU from overheating.*

##### ***Replacing the CPU***

*While replacing the CPU, always turn off the ATX power supply or unplug the power supply's power cord from grounded outlet first to ensure the safety of CPU.*

## CPU Installation Procedures for Socket 478

1. Please turn off the power and unplug the power cord before installing the CPU.
2. Pull the lever sideways away from the socket. Make sure to raise the lever up to a 90-degree angle.
3. Look for the gold arrow. The gold arrow should point towards the lever pivot. The CPU can only fit in the correct orientation.
4. If the CPU is correctly installed, the pins should be completely embedded into the socket and can not be seen. Please note that any violation of the correct installation procedures may cause permanent damages to your mainboard.
5. Press the CPU down firmly into the socket and close the lever. As the CPU is likely to move while the lever is being closed, always close the lever with your fingers pressing tightly on top of the CPU to make sure the CPU is properly and completely embedded into the socket.

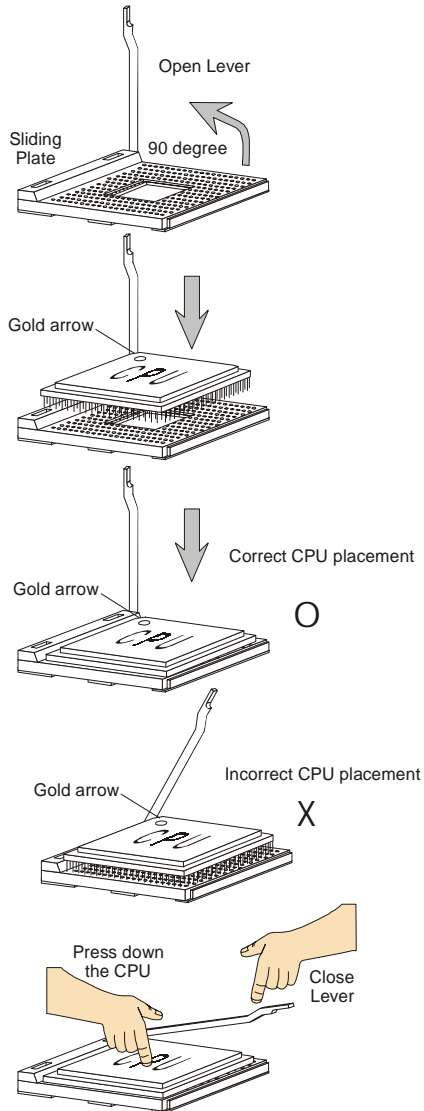



## Installing the CPU Fan

As processor technology pushes to faster speeds and higher performance, thermal management becomes increasingly important. To dissipate heat, you need to attach the CPU cooling fan and heatsink on top of the CPU. Follow the instructions below to install the Heatsink/Fan:

1. Locate the CPU and its retention mechanism on the motherboard.
2. Position the heatsink onto the retention mechanism.

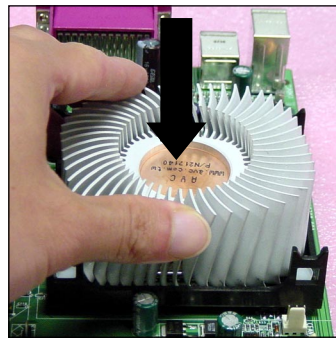
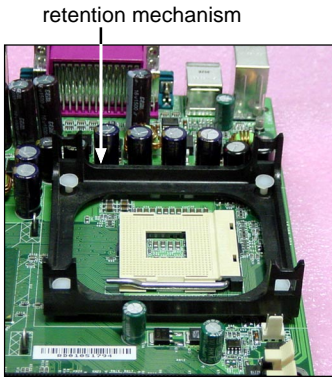

3. Mount the fan on top of the heatsink. Press down the fan until its four clips get wedged in the holes of the retention mechanism.
4. Press the two levers down to fasten the fan. Each lever can be pressed down in only ONE direction.

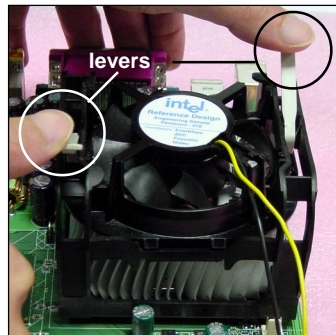
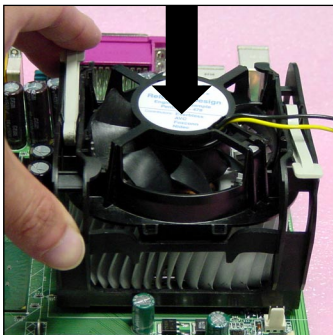

5. Connect the fan power cable from the mounted fan to the 3-pin fan power connector on the board.

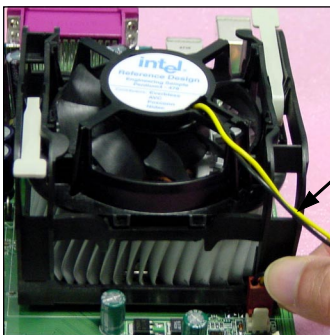

fan power cable



**NOTES**

---

## Memory

The mainboard provides 2 slots for 184-pin, 2.5V DDR DIMM with 4 memory banks. You can install DDR333/PC2700, DDR266/PC2100, or DDR200/PC1600 SDRAM modules on the DDR DIMM slots (DDR 1~2). To operate properly, at least one DIMM module must be installed.

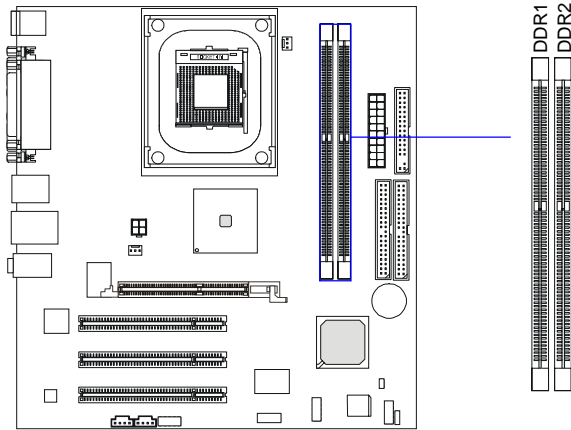

### Introduction to DDR SDRAM

DDR (Double Data Rate) SDRAM is similar to conventional SDRAM, but doubles the rate by transferring data twice per cycle. It uses 2.5 volts as opposed to 3.3 volts used in SDR SDRAM, and requires 184-pin DIMM modules rather than 168-pin DIMM modules used by SDR SDRAM. High memory bandwidth makes DDR an ideal solution for high performance PC, workstations and servers.

## DDR Module Combination

You can install either single-sided or double-sided 184-pin DDR DIMM modules into DDR DIMM slots to meet your needs. Different from the SDR DIMM, the DDR DIMM has only one notch on the center of module. The number of pins on either side of the breaks are different. The module will only fit in the right orientation.

You can install memory modules in any combination as follows:

| Slot                                   | Memory Module | Total Memory |
|--|---------------|--------------|
| DIMM 1<br>(Bank 0 & 1)                 | S/D           | 64MB~1GB     |
| DIMM 2<br>(Bank 2 & 3)                 | S/D           | 64MB~1GB     |
| <b>Maximum System Memory Supported</b> |               | 64MB~2GB     |

**S: Single Side**

**D: Double Side**

## Installing DDR Modules

1. The DDR DIMM has only one notch on the center of module. The module will only fit in the right orientation.
2. Insert the DIMM memory module vertically into the DIMM slot. Then push it in until the golden finger on the memory module is deeply inserted in the socket.
3. The plastic clip at each side of the DIMM slot will automatically close.

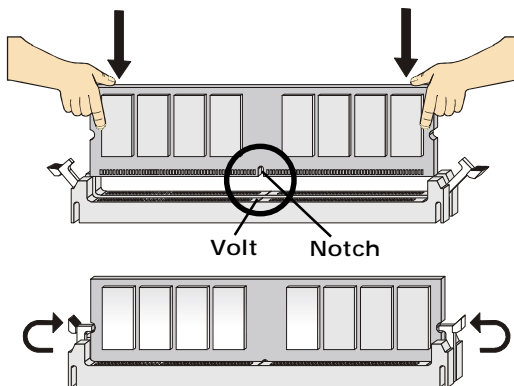

*TIP: You can barely see the golden finger if the module is deeply inserted in the socket.*

## Power Supply

The mainboard supports ATX power supply for the power system. Before inserting the power supply connector, always make sure that all components are installed properly to ensure that no damage will be caused.

### ATX 20-Pin Power Connector: CONN1

This connector allows you to connect to an ATX power supply. To connect to the ATX power supply, make sure the plug of the power supply is inserted in the proper orientation and the pins are aligned. Then push down the power supply firmly into the connector.

### ATX 12V Power Connector: JPW2

This 12V power connector is used to provide power to the CPU.

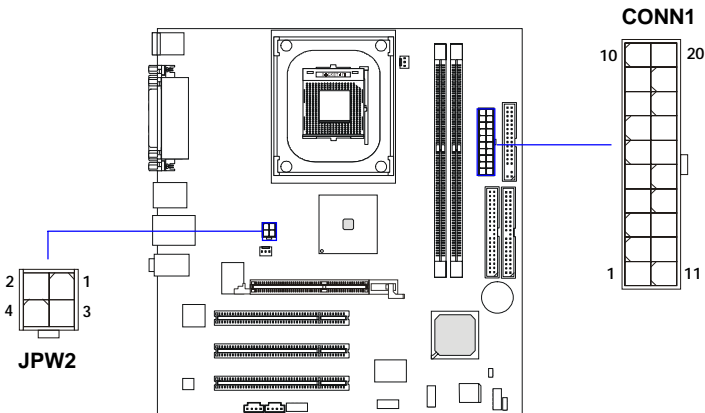

**JPW2 Pin Definition**

| PIN | SIGNAL |
|-----|--------|
| 1   | GND    |
| 2   | GND    |
| 3   | 12V    |
| 4   | 12V    |

**CONN1 Pin Definition**

| PIN | SIGNAL | PIN | SIGNAL |
|-----|--------|-----|--------|
| 1   | 3.3V   | 11  | 3.3V   |
| 2   | 3.3V   | 12  | -12V   |
| 3   | GND    | 13  | GND    |
| 4   | 5V     | 14  | PS_ON  |
| 5   | GND    | 15  | GND    |
| 6   | 5V     | 16  | GND    |
| 7   | GND    | 17  | GND    |
| 8   | PW_OK  | 18  | -5V    |
| 9   | 5V_SB  | 19  | 5V     |
| 10  | 12V    | 20  | 5V     |

## Back Panel

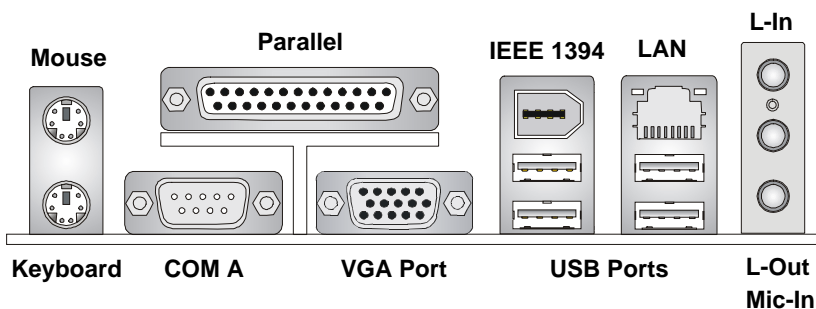

### Mouse/Keyboard Connector

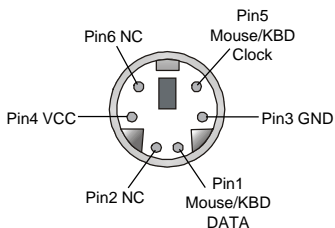

### IEEE 1394 Port

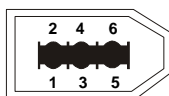

| PIN | SIGNAL |
|-----|--------|
| 1   | PWR    |
| 2   | GND    |
| 3   | TPB-   |
| 4   | TPB+   |
| 5   | TPA-   |
| 6   | TPA+   |

### Serial Port

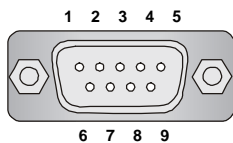

| PIN | SIGNAL |
|-----|--------|
| 1   | DCD    |
| 2   | SIN    |
| 3   | SOUT   |
| 4   | DTR    |
| 5   | GND    |
| 6   | DSR    |
| 7   | RTS    |
| 8   | CTS    |
| 9   | RI     |

### USB Ports

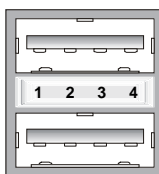

| PIN | SIGNAL |
|-----|--------|
| 1   | VCC    |
| 2   | -Data  |
| 3   | +Data  |
| 4   | GND    |

### VGA Port

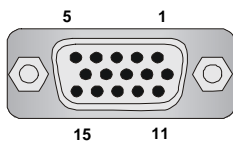

| PIN | SIGNAL          |
|-----|-----------------|
| 1   | RED             |
| 2   | GREEN           |
| 3   | BLUE            |
| 4   | N/C             |
| 5   | GND             |
| 6   | GND             |
| 7   | GND             |
| 8   | GND             |
| 9   | +5V             |
| 10  | GND             |
| 11  | N/C             |
| 12  | SDA             |
| 13  | Horizontal Sync |
| 14  | Vertical Sync   |
| 15  | SCL             |

### RJ-45 LAN Jack

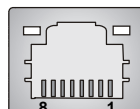

| PIN | SIGNAL | PIN | SIGNAL |
|-----|--------|-----|--------|
| 1   | TDP    | 5   | NC     |
| 2   | TDN    | 6   | RDN    |
| 3   | RDP    | 7   | NC     |
| 4   | NC     | 8   | NC     |

## Connectors

The mainboard provides connectors to connect to FDD, IDE HDD, case, modem, LAN, USB ports, and CPU/system fans.

### Floppy Disk Drive Connector: FDD1

The mainboard provides a standard floppy disk drive connector that supports 360K, 720K, 1.2M, 1.44M and 2.88M floppy disk types.

### Hard Disk Connectors: PRIMAR1 & SECON1

The mainboard has a 32-bit Enhanced PCI IDE and Ultra DMA 33/66/100 controller that provides PIO mode 0~4, Bus Master, and Ultra DMA33/66/100 function. You can connect up to four hard disk drives, CD-ROM, 120MB Floppy (reserved for future BIOS) and other devices. These connectors support the provided IDE hard disk cable.

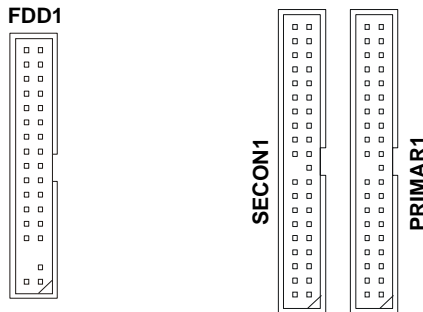

**PRIMAR1** (Primary IDE Connector)

The first hard drive should always be connected to PRIMAR1. PRIMAR1 can connect a Master and a Slave drive. You must configure second hard drive to Slave mode by setting the jumper accordingly.

**SECON1** (Secondary IDE Connector)

SECON1 can also connect a Master and a Slave drive.



#### MSI Reminds You...

*If you install two hard disks on cable, you must configure the second drive to Slave mode by setting its jumper. Refer to the hard disk documentation supplied by hard disk vendors for jumper setting instructions.*

## CD-In Connector: JCD1

This connector is provided for CD-ROM audio.

## Aux Line-In Connector: JAUX1

The connector is for DVD add-on card with Line-in connector.

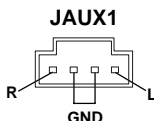
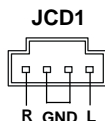

## Front Panel Audio Connector: JAUD1

The JAUD1 front panel audio connector allows you to connect to the front panel audio and is compliant with Intel® Front Panel I/O Connectivity Design Guide.



### Pin Definition

| PIN | SIGNAL       | DESCRIPTION  |
|-----|--------------|--|
| 1   | AUD_MIC      | Front panel microphone input signal                    |
| 2   | AUD_GND      | Ground used by analog audio circuits                   |
| 3   | AUD_MIC_BIAS | Microphone power                                       |
| 4   | AUD_VCC      | Filtered +5V used by analog audio circuits             |
| 5   | AUD_FPOUT_R  | Right channel audio signal to front panel              |
| 6   | AUD_RET_R    | Right channel audio signal return from front panel     |
| 7   | HP_ON        | Reserved for future use to control headphone amplifier |
| 8   | KEY          | No pin   |
| 9   | AUD_FPOUT_L  | Left channel audio signal to front panel               |
| 10  | AUD_RET_L    | Left channel audio signal return from front panel      |



### MSI Reminds You...

*If you don't want to connect to the front audio header, pins 5 & 6, 9 & 10 have to be jumpered in order to have signal output directed to the rear audio ports. Otherwise, the Line-Out connector on the back panel will not function.*





## Fan Power Connectors: CPU\_FAN1, REAR\_FAN1

The CPU\_FAN1 (processor fan) and REAR\_FAN1 (chipset fan) support system cooling fan with +12V. It supports three-pin head connector. When connecting the wire to the connectors, always take note that the red wire is the positive and should be connected to the +12V, the black wire is Ground and should be connected to GND.

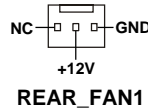
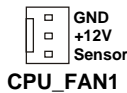

**MSI Reminds You...**

*Always consult the vendors for proper CPU cooling fan.*

## Front Panel Connector: JFP1

The mainboard provides one front panel connector for electrical connection to the front panel switches and LEDs. The JFP1 is compliant with Intel® Front Panel I/O Connectivity Design Guide.

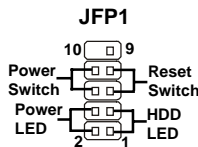

**JFP1 Pin Definition**

| PIN | SIGNAL     | DESCRIPTION                                 |
|-----|------------|---|
| 1   | HD_LED_P   | Hard disk LED pull-up                       |
| 2   | FP PWR/SLP | MSG LED pull-up                             |
| 3   | HD_LED_N   | Hard disk active LED                        |
| 4   | FP PWR/SLP | MSG LED pull-up                             |
| 5   | RST_SW_N   | Reset Switch low reference pull-down to GND |
| 6   | PWR_SW_P   | Power Switch high reference pull-up         |
| 7   | RST_SW_P   | Reset Switch high reference pull-up         |
| 8   | PWR_SW_N   | Power Switch low reference pull-down to GND |
| 9   | RSVD_DNU   | Reserved. Do not use.                       |

## IEEE 1394 Connector: J1394\_2

The mainboard provides one IEEE1394 pin header that allows you to connect IEEE 1394 ports via an external IEEE1394 bracket.



**Pin Definition**

| PIN | SIGNAL       | PIN | SIGNAL      |
|-----|--------------|-----|-------------|
| 1   | TPA+         | 2   | TPA-        |
| 3   | Ground       | 4   | Ground      |
| 5   | TPB+         | 6   | TPB-        |
| 7   | Cable power  | 8   | Cable power |
| 9   | Key (no pin) | 10  | Ground      |

## Front USB Connector: JUSB1

The mainboard provides one USB 2.0 pin header *JUSB1* that is compliant with Intel® I/O Connectivity Design Guide. USB 2.0 technology increases data transfer rate up to a maximum throughput of 480Mbps, which is 40 times faster than USB 1.1, and is ideal for connecting high-speed USB interface peripherals such as **USB HDD, digital cameras, MP3 players, printers, modems and the like.**

**JUSB1**

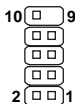

**Pin Definition**

| PIN | SIGNAL | PIN | SIGNAL |
|-----|--------|-----|--------|
| 1   | USBPWR | 2   | USBPWR |
| 3   | USBP4- | 4   | USBP5- |
| 5   | USBP4+ | 6   | USBP5+ |
| 7   | GND    | 8   | GND    |
| 9   | NC     | 10  | USBOC  |

## Jumpers

The motherboard provides the following jumpers for you to set the computer's function. This section will explain how to change your motherboard's function through the use of jumpers.

### Clear BIOS Password Jumper: JPWD1

The jumper is used to clear the BIOS password. To clear the password, open the jumper and restart your computer.

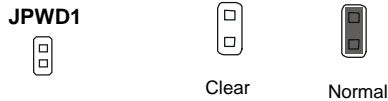

### Clear CMOS Jumper: JBAT1

There is a CMOS RAM on board that has a power supply from external battery to keep the data of system configuration. With the CMOS RAM, the system can automatically boot OS every time it is turned on. If you want to clear the system configuration, use the JBAT1 (Clear CMOS Jumper) to clear data. Follow the instructions below to clear the data:

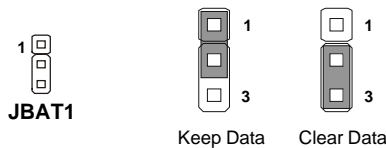

#### MSI Reminds You...

*You can clear CMOS by shorting 2-3 pin while the system is off. Then return to 1-2 pin position. Avoid clearing the CMOS while the system is on; it will damage the mainboard.*

## Slots

The motherboard provides one AGP slot and three 32-bit Master PCI bus slots.

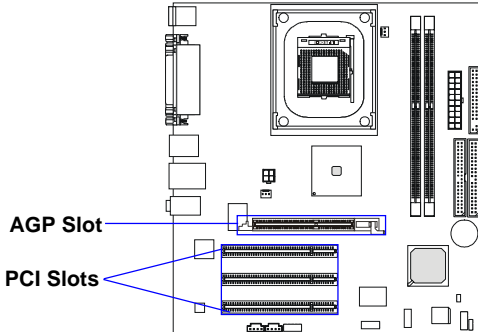

### AGP (Accelerated Graphics Port) Slot

The AGP slot allows you to insert the AGP graphics card. AGP is an interface specification designed for the throughput demands of 3D graphics. It introduces a 66MHz, 32-bit channel for the graphics controller to directly access main memory. The slot only supports **1.5V 4x** AGP card.

### PCI (Peripheral Component Interconnect) Slots

The PCI slots allow you to insert the expansion cards to meet your needs. When adding or removing expansion cards, make sure that you unplug the power supply first. Meanwhile, read the documentation for the expansion card to make any necessary hardware or software settings for the expansion card, such as jumpers, switches or BIOS configuration.

### PCI Interrupt Request Routing

The IRQ, acronym of interrupt request line and pronounced I-R-Q, are hardware lines over which devices can send interrupt signals to the microprocessor. The PCI IRQ pins are typically connected to the PCI bus INT A# ~ INT D# pins as follows:

|            | Order 1 | Order 2 | Order 3 | Order 4 |
|------------|---------|---------|---------|---------|
| PCI Slot 1 | INT A#  | INT B#  | INT C#  | INT D#  |
| PCI Slot 2 | INT B#  | INT C#  | INT D#  | INT A#  |
| PCI Slot 3 | INT C#  | INT D#  | INT A#  | INT B#  |